



**WORLD PRODUCTS INC.**

# METAL OXIDE VARISTORS EV\* SERIES

\*Environmental Varistors



**WORLD PRODUCTS INC.** || 19654 Eighth Street East || P.O. Box 517 || Sonoma, CA 95476  
Phone: (707) 996.5201 || FAX: (707) 996.3380 || [www.worldproducts.com](http://www.worldproducts.com) || [sales@worldproducts.com](mailto:sales@worldproducts.com)  
©2013 World Products Inc.



**THIS PAGE WAS INTENTIONALLY LEFT BLANK.**

**Table of Contents**

Definition of Terms (according to IEEE specifications C62.33) . . . . . 2

General Characteristics . . . . . 2

Approvals . . . . . 3

Part Numbering System . . . . . 4

Standard Dimensions and Lead Modification Options . . . . . 6

    5mm & 7mm Standard Series Thickness & Offset Dimensions . . . . . 8

    10mm & 14mm Standard Series Thickness & Offset Dimensions . . . . . 9

    20mm Standard Series Thickness & Offset Dimensions . . . . . 10

    5mm & 7mm High Energy (-J) Series Thickness & Offset Dimensions . . . . . 11

    10mm High Energy (-J) Series Thickness & Offset Dimensions . . . . . 12

    14mm High Energy (-J) Series Thickness & Offset Dimensions . . . . . 13

    20mm High Energy (-J) Series Thickness & Offset Dimensions . . . . . 14

    14mm & 20mm Ultra High Energy (-H) Series Thickness & Offset Dimensions . . . . . 15

    22mm Standard Tab Lead Thickness & Offset Dimensions . . . . . 16

    22mm Standard Wire Lead Thickness & Offset Dimensions . . . . . 17

    34mm Standard Tab Lead Thickness & Offset Dimensions . . . . . 18

    . . . . . 34mm Ultra High Energy (-H) Series-Tab Lead Thickness & Offset Dimensions . . . . . 19

    22mm Pin Type Series-Tab Lead Thickness & Offset Dimensions . . . . . 20

    34mm Pin Type Series-Tab Lead Thickness & Offset Dimensions . . . . . 21

    22mm - Uncoated with No Leads Thickness . . . . . 22

    34mm - Uncoated with No Leads Thickness . . . . . 23

Electrical Characteristics Standard Series (5, 7, 10, 14, & 20mm) . . . . . 24

Electrical Characteristics Standard Series (22mm) . . . . . 29

Electrical Characteristics Standard Series (34mm) . . . . . 30

Electrical Characteristics High Energy (-J) Series (5, 7, 10, 14, & 20mm) . . . . . 31

Electrical Characteristics Ultra High Energy (-H) Series (14 & 20mm) . . . . . 36

Electrical Characteristics Ultra High Energy (-H) Series (34mm) . . . . . 38

Peak Pulse and Derating Curve . . . . . 39

Temperature Derating Curve Power and Energy Rating vs. Temperature . . . . . 39

Soldering Profile . . . . . 39

Power Dissipation Ratings . . . . . 39

V-I Characteristics . . . . . 40

Standard Bulk Packaging . . . . . 44

5mm/7mm Taping Specs . . . . . 45

10mm Taping Specs . . . . . 47

14mm Taping Specs . . . . . 51

20mm Taping Specs . . . . . 55

## Definition of Terms (according to IEEE specifications C62.33)

**Average Power Dissipation:** Tested using two consecutive pulses at rated peak current using a 10/1000 $\mu$ s test waveform with a minimum pulse period of 60 seconds between pulses (IEC 61000-4-5).

**Rated RMS Voltage, Rated DC Voltage:** The maximum designated values of power system voltage that may be applied continuously between the terminals of a device.

**Varistor Voltage:** Test characteristic that is used to classify varistors by type. A test current of 1mA DC is typically used to determine varistor voltage classification type. Varistor voltage clamping characteristics can be defined at various test levels.

**Rated Peak Single Pulse Transient Current:** Maximum surge current, 8/20 $\mu$ s waveform which a varistor is rated to withstand for a single surge.

**Rated Single Pulse Transient Energy:** Maximum allowable energy for a single impulse (see specified waveforms).

**Maximum Clamping Voltage:** Measured peak voltage across the device terminals when a current impulse of specified amplitude and waveform is conducted through the varistor.

**Typical Capacitance:** Typical capacitance values are measured at a test frequency of 1KHZ.

## General Characteristics

Storage Temperature	- 55° C to + 125° C
Operating Surface Temperature	125° C
Operating Ambient Temperature	- 55° C to + 85° C (without derating)
Maximum Voltage-Temperature Coefficient	< -0.01 % / °C
Insulation Resistance	1000 Megohm min.
Hi POT (Leads to Case, 1 min.)	3000 VDC*
Typical Response Time	< 15 nsec.
Epoxy Rating	94 V-0
Current/Energy Derating (>85°C)	- 2.5 % / °C
DC Leakage Current	200 $\mu$ A Max (at rated DC working voltage)
Solderability	MIL STD 202G, Method 208H
Failure Criteria	Voltage change $\pm$ 10% from initially measured Varistor Voltage. When determining if varistor is within aforementioned criteria the same temperature must be observed as was used for initial Varistor Voltage measurements.

\*Rating is for standard epoxy, for flame retardant coating (suffix "S") disk sizes 5mm to 20mm rating is 2000 VDC, for disk sizes 22mm & 34mm rating is 2500VDC.

## Approvals

APPROVAL & FILE #	DISK SIZE																				
	5mm					7mm					10mm					14mm					
Suffix Codes	Nil	J	A	B	S	Nil	J	A	B	S	Nil	J	A	B	S	Nil	J	H	A	B	S
UL 1449 3RD EDITION, FILE#E321567*	√	√	√	√	√	√	√	√	√	√	√	√	√	√	√	√	√	√	√	√	√
CUL 1449 3RD EDITION, FILE#E321567*	√	√	√	√	√	√	√	√	√	√	√	√	√	√	√	√	√	√	√	√	√
VDE IEC60950-1 Annex Q	PENDING					PENDING					PENDING					PENDING					

APPROVAL & FILE #	DISK SIZE														
	20mm						22mm**					34mm			
Suffix Codes	Nil	J	H	A	B	S	Nil	A	P	Y	W	Nil	H	A	P
UL 1449 3RD EDITION, FILE#E321567*	√	√	√	√	√	√	√	√	√	PE	√	√	√	√	√
CUL 1449 3RD EDITION, FILE#E321567*	√	√	√	√	√	√	√	√	√	PE	√	√	√	√	√
VDE IEC60950-1 Annex Q FILE #40031768	PENDING						PE	PE	PE	√	PE	PENDING			

**NOTES:**

- Nil** = 5mm through 20mm Standard Series wire leads. 22mm & 34mm Standard Series (tab leads).
- J** = 5mm through 20mm High Energy series.
- H** = 14mm, 20mm & 34mm Ultra High Energy series. (not applicable for 34mm "A" Type)
- B** = Uncoated disk (with leads).
- A** = Uncoated disk (without leads), includes "L" option for 22mm disk size.
- S** = Flame retardant coating option.
- P** = 22mm & 34mm Pin Type.
- Y** = 22mm disk size with 14mm lead spacing.
- W** = 22mm disk size with wire lead.

**PE = PENDING**

\*UL1449 3RD Edition SPD Application Category Type designation:

- 5mm (11VAC – 40VAC) = other 1
- 5mm (50VAC – 360VAC) = other 2
- 7mm (All) = other 3
- 10mm (11VAC – 40VAC) = other 4
- 10mm (50VAC – 680VAC) = other 5
- 14mm = Type 3
- 20mm = Type 2
- 22mm = Type 2
- 34mm = Type 1

\*\*For 22mm disk size only, standard 22mm leadspacing option is UL/CUL recognized. 22mm disk size, with 14mm lead spacing option is pending UL/CUL recognition.

## Part Numbering System

<b>EV</b>	<b>20</b>	<b>D</b>	<b>130</b>	<b>K</b>	<b>-</b>	<b>J</b>	<b>S</b>	<b>I</b>	<b>X</b>
(1)	(2)	(3)	(4)	(5)	(6)	(7)	(8)	(9)	(10)

**(1) Series**

**EV**= Environmental Varistor  
(All parts are RoHS compliant & halogen free.)

**(2) Disk Diameter**

**05** = 5mm, **07** = 7mm, **10** = 10mm,  
**14** = 14mm, **20** = 20mm, **22** = 22mm,  
**34** = 34mm

**(3) Type**

**D** = Standard

**(4) AC RMS Voltage Rating**

**130** = 130VAC

**(5) Tolerance**

**J** = ± 5%, **K** = ±10%

**(6) Lead Type**

**Nil** = Standard wire straight lead configuration applies for 5mm to 20mm disk size. (for 22mm & 34mm disk size standard tab lead configuration applies).  
**P** = Pin Type (only offered for 22mm & 34mm disk size, standard lead configuration applies).  
**B** = Uncoated disk with leads (standard lead configuration applies).  
**A** = Uncoated disk without leads. For 22mm disk size with optional dimension of 20mm x 20mm ± 1mm use "L" in this position.  
**PB** = Uncoated disk Pin Type (offered only for 22mm & 34mm disk size, standard tab lead configuration applies).  
**W** = Wire lead for 22mm disk size.

**(7) Surge Type**

**Nil** = Standard Series  
**J** = High Energy (for 5mm through 20mm)  
**H** = Ultra High Energy (14mm, 20mm & 34mm)

**(8) Coating Option**

**Nil** = Standard halogen free epoxy coating  
**S** = Flame retardant coating (only available on for disk sizes 5mm to 20mm)

**(9) Lead Configuration Options (wire or tab type) (see notes below)**

**Nil** = Straight lead  
**I** = Inward Crimp (wire leads only-not applicable for 22mm & 34mm disk sizes.)  
**O** = Outward Crimp (wire leads only-not applicable for 22mm & 34mm disk sizes.)  
**L** = InLine Crimp (wire leads only-not applicable for 22mm & 34mm disk sizes.)  
**N** = For ≥420VAC parts requested without inline crimp **(see note 3 below)**.

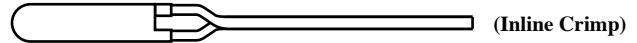

**(10) Lead Spacing Option**

**Nil** = Standard lead spacing (please reference standard dimensions and lead modification options)  
**X** = 10mm lead spacing for 20mm disk size.  
**Y** = 14mm lead spacing for 22mm disk size.  
**U** = 22mm lead spacing for 34mm disk size.  
**F** = 5mm lead spacing for 10mm and 14mm disk size.

**NOTES:**

- For taped parts see taping specifications for suffix code. (Note: taping suffix codes follow format of basic part number, therefore, taping suffix code may be located in positions 6, 8, 9 or 10.)
- All disk sizes are available in several lead options. Contact WPI for additional information.
- For disk sizes 5mm through 20mm rated - parts ≥420VAC provided standard with inline crimp (see illustration above) for straight disk seating on PC boards.

Part Marking

(5mm – 20mm)

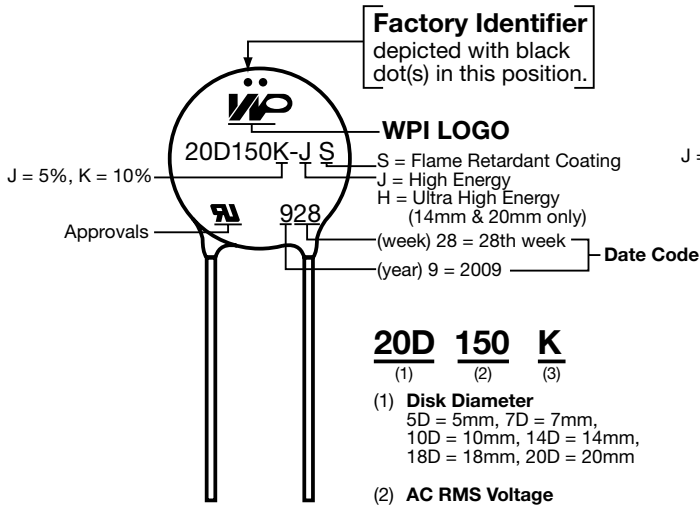

- 20D 150 K**
- (1) (2) (3)
- Disk Diameter**  
 5D = 5mm, 7D = 7mm,  
 10D = 10mm, 14D = 14mm,  
 18D = 18mm, 20D = 20mm
  - AC RMS Voltage**  
 150 = 150VAC
  - Tolerance**  
 K = 10%

(22mm & 34mm)

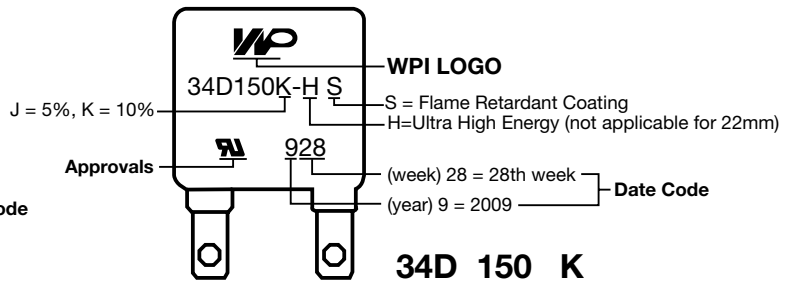

- 34D 150 K**
- (1) (2) (3)
- Disk Diameter**  
 22D = 22mm  
 34D = 34mm
  - AC RMS Voltage**  
 150 = 150VAC
  - Tolerance**  
 K = 10%

(22mm)

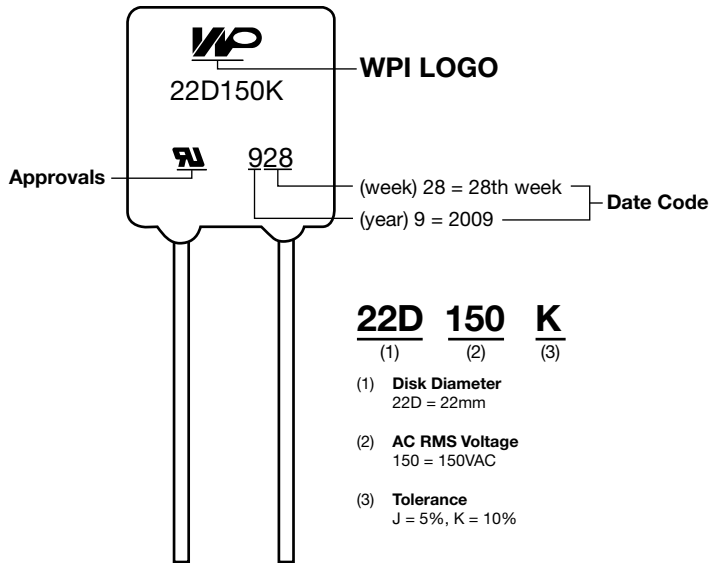

- 22D 150 K**
- (1) (2) (3)
- Disk Diameter**  
 22D = 22mm
  - AC RMS Voltage**  
 150 = 150VAC
  - Tolerance**  
 J = 5%, K = 10%

Date Code 928 = First digit represents year (9 = 2009). Second and third digits represent the week of the year.

Standard Dimensions and Lead Modification Options

5mm, 7mm, 10mm, 14mm & 20mm

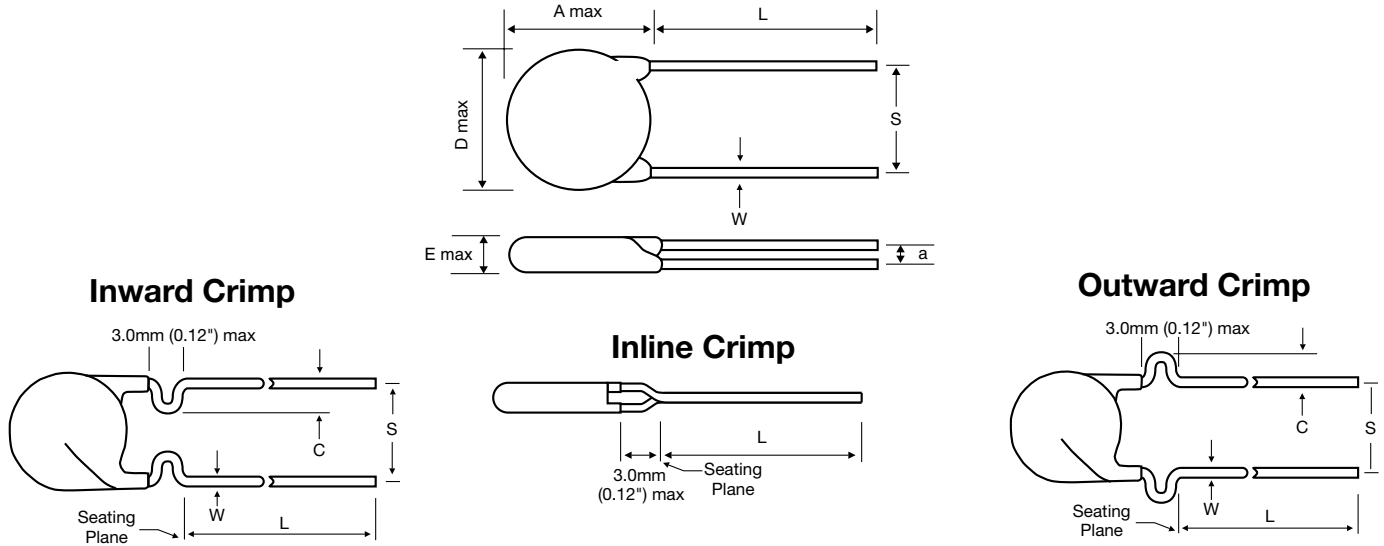

NOTE: For uncoated "A" Type (without leads) and "B" Type (with leads) consult World Products, Inc. for exact dimensions.

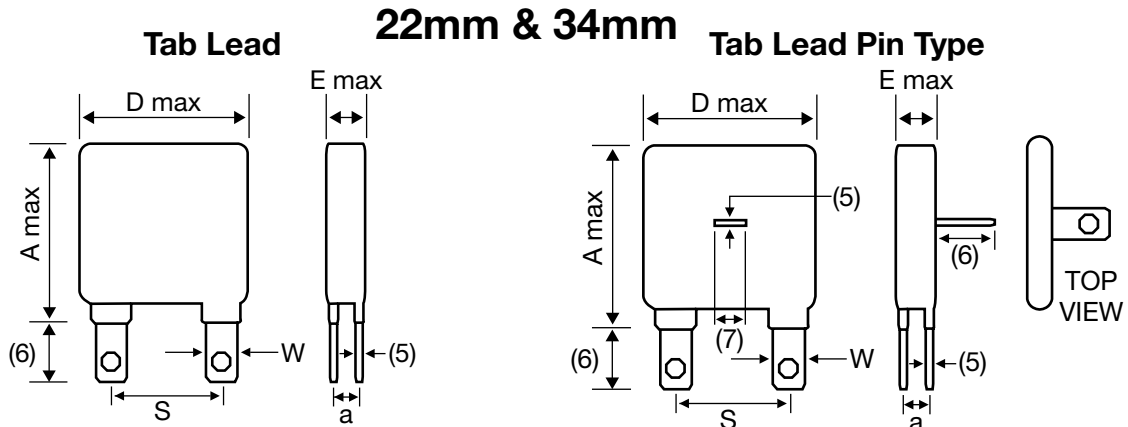

NOTE: For 22mm disk size, there is no hole in the lead for 14mm lead spacing option.

22mm Wire Lead

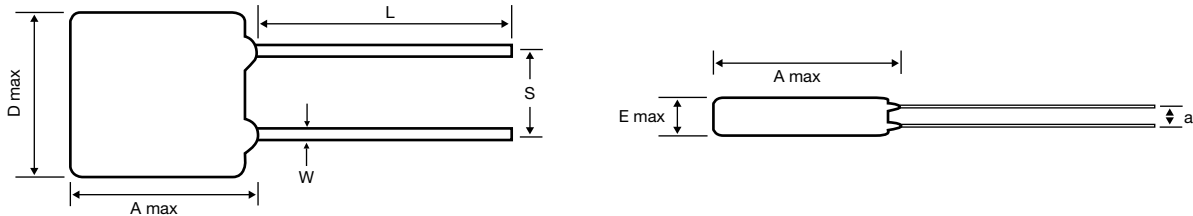

22mm & 34mm Uncoated Disk Series (No Leads)

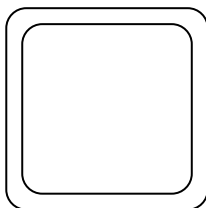

Standard Disk Size

\*22mm = 22.5mm ± 0.5mm X 25.25 ± 0.5mm  
 34mm = 33.5mm ± 1mm X 33.5mm ± 1mm

\*Also available 20mm ± 1mm X 20mm ± 1mm (by special request).

NOTE: Please see "E" maximum thickness dimension by part number.

All disk sizes are available in several lead options. Please contact WPI for additional information.



**Standard Dimensions and Lead Modification Options (continued)**

**Wire Lead Parts (Standard Epoxy) <sup>(9)</sup>**

Disk Size	A max		D max		S		W nom		C		L (min)		Dimension E max & a
	mm	in	mm	in	mm ± 1	in ± .04	mm ± .02	in ± .001	mm	in	mm	in	
5	9	0.4	7	0.28	5	0.20	0.6	0.024	1.6 ± 0.4	0.06 ± 0.016	25/.98	Please see "E" Maximum Thickness and Off-set "a" Dimension by Part Number.	
7	11	0.4	9	0.35	5	0.20	0.6	0.024	1.6 ± 0.4	0.06 ± 0.016			
10	15.5	0.6	12.5	0.49	7.5	0.30	0.8	0.031	1.6 ± 0.4	0.06 ± 0.016			
14	20	0.8	16.5	0.65	7.5	0.30	0.8	0.031	1.6 ± 0.4	0.06 ± 0.016			
20	26	1.0	23	0.91	7.5	0.30	0.8	0.031	2.05 ± 0.4	0.08 ± 0.016			
20 <sup>(9)</sup>	26	1.0	23	0.91	10	0.39	1.0	0.039	2.05 ± 0.4	0.08 ± 0.016			
22	28	1.1	28	1.1	11.25	.44	1.0 ± .1	.039 ± .004	N/A	N/A			

**Tab Lead Parts (Standard Epoxy) <sup>(9)</sup>**

Disk Size	A max		D max		S		W nom		C		Dimension E max & a	
	mm	in	mm	in	mm ± 1	in ± .039	mm ± 0.2	in ± .008	mm	in		
22	28	1.1	28	1.1	22	0.87	4	0.16	N/A	N/A	Please see "E" Maximum Thickness and Off-set "a" Dimension by Part Number.	
22 <sup>(10)</sup>	28	1.1	2.8	1.1	14	.55	4	0.16	N/A	N/A		
mm	mm	in	mm	in	mm ± 1	in ± .039	mm ± 0.5	in ± .02	mm	in		
34	42	1.65	37	1.46	25.4	1	7	.275	N/A	N/A		
34 <sup>(8)</sup>	42	1.65	37	1.46	22	0.87	6	0.24	N/A	N/A		

**NOTES**

- Maximum epoxy extending on leads (measured from bottom portion of disk) is 3mm for all disk sizes with exception of 20mm disk size which is 4mm.
- Reduced dimensions, special lead diameters and special lead spacing may be available upon request.
- 20mm disk size** - for 10mm leadspacing use suffix "X".
- 22mm and 34mm disk size Pin Type dimensions are the same as 22mm and 34mm disk size Tab Lead type (except where noted).
- 22mm disk size** - .5mm (.02") max.  
**34mm disk size** - .7mm (.028") max.
- Dimension: 15mm (.6") ± 1mm (.039")
- 22mm disk size** - 4mm (0.16") ± 2mm (0.8").  
**34mm disk size** - 6.5mm (0.26") ± 0.5mm (.02").
- 34mm disk size** - for 22mm lead spacing use suffix "U".
- For "flame retardant coating" (suffix "S") dimensions "A", "D", "E", and "a" add 10% (x1.10) as this coating is thicker.
- 22mm disk size** - for 14mm lead spacing use suffix "Y".

**Standard Dimensions and Lead Modification Options (continued)**

**E Max Dimensions for EV Standard Series (5, 7, 10, 14 and 20mm) using standard epoxy coating. For flame retardant coating (suffix “s”) dimensions “E” & “a” add 10% (x1.10) as this coating is thicker.**

Dimensions are in mm (inches)

**5mm**

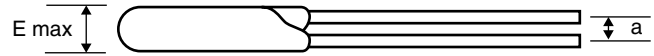

Part Number	E Max mm (in)	Off-set Dimension (a) ±1 (±0.04) mm (in)
EV05D11K	3.4 (.13)	1.3 (.05)
EV05D14K	3.5 (.14)	1.3 (.05)
EV05D17K	3.8 (.15)	1.4 (.06)
EV05D20K	3.4 (.13)	1.2 (.05)
EV05D25K	3.6 (.14)	1.3 (.05)
EV05D30K	3.8 (.15)	1.5 (.06)
EV05D35K	3.9 (.15)	1.6 (.06)
EV05D40K	4.0 (.16)	1.8 (.07)
EV05D50K	3.4 (.13)	1.2 (.05)
EV05D60K	3.6 (.14)	1.2 (.05)
EV05D75K	3.8 (.15)	1.3 (.05)
EV05D95K	4.0 (.16)	1.5 (.06)
EV05D120K	3.2 (.13)	1.4 (.05)

Part Number	E Max mm (in)	Off-set Dimension (a) ±1 (±0.04) mm (in)
EV05D130K	3.4 (.13)	1.5 (.06)
EV05D140K	3.5 (.14)	1.5 (.06)
EV05D150K	3.6 (.14)	1.6 (.06)
EV05D180K	3.8 (.15)	1.8 (.07)
EV05D195K	4.0 (.16)	1.6 (.06)
EV05D210K	4.2 (.17)	1.7 (.07)
EV05D230K	4.4 (.17)	1.8 (.07)
EV05D250K	4.6 (.18)	1.9 (.08)
EV05D275K	4.8 (.19)	1.8 (.07)
EV05D300K	5.0 (.20)	2.4 (.09)
EV05D320K	5.1 (.20)	2.4 (.09)
EV05D360K	5.4 (.21)	2.6 (.10)

**7mm**

Part Number	E Max mm (in)	Off-set Dimension (a) ±1 (±0.04) mm (in)
EV07D11K	3.4 (.13)	1.3 (.05)
EV07D14K	3.5 (.14)	1.3 (.05)
EV07D17K	3.8 (.15)	1.4 (.06)
EV07D20K	3.4 (.13)	1.2 (.05)
EV07D25K	3.6 (.14)	1.3 (.05)
EV07D30K	3.8 (.15)	1.5 (.06)
EV07D35K	3.9 (.15)	1.6 (.06)
EV07D40K	4.0 (.16)	1.8 (.07)
EV07D50K	3.4 (.13)	1.2 (.05)
EV07D60K	3.6 (.14)	1.2 (.05)
EV07D75K	3.8 (.15)	1.3 (.05)
EV07D95K	4.0 (.16)	1.4 (.06)
EV07D120K	3.2 (.13)	1.4 (.05)
EV07D130K	3.4 (.13)	1.5 (.06)
EV07D140K	3.5 (.14)	1.5 (.06)

Part Number	E Max mm (in)	Off-set Dimension (a) ±1 (±0.04) mm (in)
EV07D150K	3.6 (.14)	1.6 (.06)
EV07D180K	3.8 (.15)	1.8 (.07)
EV07D195K	4.0 (.16)	1.6 (.06)
EV07D210K	4.2 (.17)	1.7 (.07)
EV07D230K	4.4 (.17)	1.8 (.07)
EV07D250K	4.6 (.18)	1.9 (.08)
EV07D275K	4.8 (.19)	2.0 (.08)
EV07D300K	5.0 (.20)	2.4 (.10)
EV07D320K	5.1 (.20)	2.0 (.09)
EV07D360K	5.4 (.20)	2.6 (.10)
EV07D390K	5.8 (.24)	2.6 (.10)
EV07D420K	6.0 (.24)	*3.0 (.12)
EV07D460K	6.2 (.24)	*3.3 (.13)
EV07D485K	6.4 (.25)	*3.4 (.13)
EV07D510K	6.8 (.27)	*3.5 (.14)

\* Parts rated ≥420VAC come standard with inline crimp for straight disk seating on PC boards. For these parts, the “a” dimension is not applicable. If ≥420VAC parts are required without inline crimp, please reference “Part Number System” position 9 and add suffix “N” then reference “a” dimension above.

**Standard Dimensions and Lead Modification Options (continued)**

**E Max Dimensions for EV Standard Series (5, 7, 10, 14 and 20mm) using standard epoxy coating. For flame retardant coating (suffix “s”) dimensions “E” & “a” add 10% (x1.10) as this coating is thicker.**

Dimensions are in mm (inches)

**10mm**

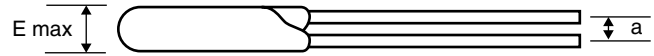

Part Number	E Max mm (in)	Off-set Dimension (a) ±1 (±0.04) mm (in)
EV10D11K	3.8 (.15)	1.4 (.06)
EV10D14K	3.9 (.15)	1.5 (.06)
EV10D17K	4.2 (.17)	1.6 (.06)
EV10D20K	3.8 (.15)	1.8 (.07)
EV10D25K	4.0 (.16)	1.6 (.06)
EV10D30K	4.2 (.17)	1.7 (.07)
EV10D35K	4.3 (.17)	1.8 (.07)
EV10D40K	4.4 (.17)	2.1 (.08)
EV10D50K	3.8 (.15)	1.4 (.05)
EV10D60K	4.0 (.16)	1.4 (.06)
EV10D75K	4.2 (.17)	1.5 (.06)
EV10D95K	4.4 (.17)	1.7 (.07)
EV10D120K	3.6 (.14)	1.6 (.06)
EV10D130K	3.8 (.15)	1.7 (.07)
EV10D140K	3.9 (.15)	1.8 (.07)
EV10D150K	4.0 (.16)	1.9 (.07)
EV10D180K	4.2 (.17)	2.0 (.08)
EV10D195K	4.4 (.17)	1.8 (.07)

Part Number	E Max mm (in)	Off-set Dimension (a) ±1 (±0.04) mm (in)
EV10D210K	4.6 (.18)	1.9 (.08)
EV10D230K	4.8 (.19)	2.0 (.08)
EV10D250K	5.0 (.20)	2.1 (.08)
EV10D275K	5.2 (.21)	2.1 (.08)
EV10D300K	5.4 (.21)	2.6 (.10)
EV10D320K	5.5 (.22)	2.6 (.10)
EV10D360K	5.9 (.23)	2.8 (.10)
EV10D390K	6.2 (.24)	3.1 (.12)
EV10D420K	6.4 (.25)	*3.3 (.13)
EV10D460K	6.6 (.26)	*3.5 (.14)
EV10D485K	6.8 (.27)	*3.6 (.14)
EV10D510K	7.2 (.28)	*3.8 (.15)
EV10D550K	7.6 (.30)	*4.1 (.16)
EV10D625K	8.0 (.32)	*4.4 (.17)
EV10D680K	8.5 (.37)	*4.9 (.19)
EV10D750K	9.5 (.37)	*5.4 (.21)
EV10D1100K	11.5 (.45)	*6.4 (.25)

**14mm**

Part Number	E Max mm (in)	Off-set Dimension (a) ±1 (±0.04) mm (in)
EV14D11K	3.8 (.15)	1.4 (.06)
EV14D14K	3.9 (.15)	1.5 (.06)
EV14D17K	4.2 (.17)	1.7 (.07)
EV14D20K	3.8 (.15)	1.9 (.08)
EV14D25K	4.0 (.16)	1.7 (.07)
EV14D30K	4.2 (.17)	1.8 (.07)
EV14D35K	4.3 (.17)	2.0 (.08)
EV14D40K	4.4 (.17)	2.2 (.09)
EV14D50K	3.8 (.15)	1.4 (.06)
EV14D60K	4.0 (.16)	1.5 (.06)
EV14D75K	4.2 (.17)	1.5 (.06)
EV14D95K	4.4 (.17)	1.7 (.07)
EV14D120K	3.6 (.14)	1.7 (.07)
EV14D130K	3.8 (.15)	1.8 (.07)
EV14D140K	3.9 (.15)	1.9 (.08)
EV14D150K	4.0 (.16)	1.9 (.08)
EV14D180K	4.2 (.17)	2.0 (.08)
EV14D195K	4.4 (.17)	2.0 (.08)

Part Number	E Max mm (in)	Off-set Dimension (a) ±1 (±0.04) mm (in)
EV14D210K	4.6 (.18)	2.1 (.08)
EV14D230K	4.8 (.19)	2.0 (.09)
EV14D250K	5.0 (.20)	2.3 (.09)
EV14D275K	5.2 (.21)	2.3 (.09)
EV14D300K	5.4 (.21)	2.6 (.10)
EV14D320K	5.5 (.22)	2.6 (.10)
EV14D360K	5.9 (.23)	2.8 (.10)
EV14D390K	6.2 (.24)	3.1 (.12)
EV14D420K	6.4 (.25)	*3.3 (.13)
EV14D460K	6.6 (.26)	*3.5 (.14)
EV14D485K	6.8 (.27)	*3.6 (.14)
EV14D510K	7.2 (.28)	*3.8 (.15)
EV14D550K	7.6 (.30)	*4.0 (.16)
EV14D625K	8.0 (.32)	*4.4 (.18)
EV14D680K	8.5 (.37)	*4.9 (.19)
EV14D750K	9.7 (.38)	*5.8 (.23)
EV14D1100K	11.7 (.46)	*6.9 (.27)

\* Parts rated ≥420VAC come standard with inline crimp for straight disk seating on PC boards. For these parts, the “a” dimension is not applicable. If ≥420VAC parts are required without inline crimp, please reference “Part Number System” position 9 and add suffix “N” then reference “a” dimension above.

## Standard Dimensions and Lead Modification Options (continued)

**E Max Dimensions for EV Standard Series (5, 7, 10, 14 and 20mm) using standard epoxy coating. For flame retardant coating (suffix “s”) dimensions “E” & “a” add 10% (x1.10) as this coating is thicker.**

Dimensions are in mm (inches)

**20mm**

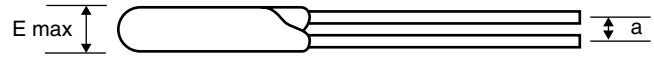

Part Number	E Max mm (in)	Off-set Dimension (a) ±1 (±0.04) mm (in)
EV20D11K	4.2 (.17)	1.5 (.06)
EV20D14K	4.3 (.17)	1.6 (.06)
EV20D17K	4.6 (.18)	1.8 (.07)
EV20D20K	4.2 (.17)	2.1 (.08)
EV20D25K	4.4 (.17)	2.1 (.08)
EV20D30K	4.6 (.18)	2.2 (.09)
EV20D35K	4.7 (.19)	2.2 (.09)
EV20D40K	4.8 (.19)	2.4 (.09)
EV20D50K	4.2 (.17)	1.5 (.06)
EV20D60K	4.4 (.17)	1.6 (.06)
EV20D75K	4.6 (.18)	1.6 (.06)
EV20D95K	4.8 (.19)	1.6 (.06)
EV20D120K	4.0 (.16)	1.8 (.07)
EV20D130K	4.2 (.07)	2.2 (.09)
EV20D140K	4.3 (.17)	2.3 (.09)
EV20D150K	4.4 (.17)	2.1 (.08)
EV20D180K	4.6 (.18)	2.3 (.09)
EV20D195K	4.8 (.19)	2.2 (.09)

Part Number	E Max mm (in)	Off-set Dimension (a) ±1 (±0.04) mm (in)
EV20D210K	5.0 (.20)	2.3 (.09)
EV20D230K	5.2 (.21)	2.4 (.09)
EV20D250K	5.4 (.21)	2.5 (.10)
EV20D275K	5.6 (.22)	2.5 (.10)
EV20D300K	5.9 (.23)	2.9 (.11)
EV20D320K	6.0 (.24)	2.8 (.10)
EV20D360K	6.5 (.26)	3.1 (.12)
EV20D390K	6.9 (.27)	3.3 (.13)
EV20D420K	7.0 (.28)	*3.5 (.14)
EV20D460K	7.2 (.28)	*3.8 (.15)
EV20D485K	7.4 (.29)	*3.9 (.15)
EV20D510K	7.8 (.31)	*4.0 (.16)
EV20D550K	8.2 (.32)	*4.4 (.17)
EV20D625K	8.7 (.34)	*4.7 (.19)
EV20D680K	9.2 (.36)	*5.2 (.20)
EV20D750K	10.2 (.40)	*6.0 (.19)
EV20D1100K	12.2 (.48)	*7.2 (.28)

\* Parts rated ≥420VAC come standard with inline crimp for straight disk seating on PC boards. For these parts, the “a” dimension is not applicable. If ≥420VAC parts are required without inline crimp, please reference “Part Number System” position 9 and add suffix “N” then reference “a” dimension above.

**Standard Dimensions and Lead Modification Options (continued)**

**E Max Dimensions for EV High Energy (-J) Series (5, 7, 10, 14 and 20mm) using standard epoxy coating. For flame retardant coating (suffix “s”) dimensions “E” & “a” add 10% (x1.10) as this coating is thicker.**

Dimensions are in mm (inches)

**5mm**

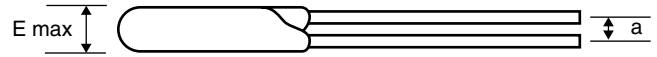

Part Number	E Max mm (in)	Off-set Dimension (a) ±1 (±0.04) mm (in)
EV05D11K-J	3.4 (.13)	1.3 (.05)
EV05D14K-J	3.5 (.14)	1.3 (.05)
EV05D17K-J	3.8 (.15)	1.4 (.06)
EV05D20K-J	3.4 (.13)	1.2 (.05)
EV05D25K-J	3.6 (.14)	1.3 (.05)
EV05D30K-J	3.8 (.15)	1.5 (.06)
EV05D35K-J	3.9 (.15)	1.6 (.06)
EV05D40K-J	4.0 (.16)	1.8 (.07)
EV05D50K-J	3.4 (.13)	1.2 (.05)
EV05D60K-J	3.6 (.14)	1.2 (.05)
EV05D75K-J	3.8 (.15)	1.3 (.05)
EV05D95K-J	4.0 (.16)	1.5 (.06)
EV05D120K-J	3.2 (.13)	1.4 (.05)

Part Number	E Max mm (in)	Off-set Dimension (a) ±1 (±0.04) mm (in)
EV05D130K-J	3.4 (.13)	1.5 (.06)
EV05D140K-J	3.5 (.14)	1.5 (.06)
EV05D150K-J	3.6 (.14)	1.6 (.06)
EV05D180K-J	3.8 (.15)	1.8 (.07)
EV05D195K-J	4.0 (.16)	1.6 (.06)
EV05D210K-J	4.2 (.17)	1.7 (.07)
EV05D230K-J	4.4 (.17)	1.8 (.07)
EV05D250K-J	4.6 (.18)	1.9 (.08)
EV05D275K-J	4.8 (.19)	1.8 (.07)
EV05D300K-J	5.0 (.20)	2.4 (.09)
EV05D320K-J	5.1 (.20)	2.4 (.09)
EV05D360K-J	5.4 (.21)	2.6 (.10)

**7mm**

Part Number	E Max mm (in)	Off-set Dimension (a) ±1 (±0.04) mm (in)
EV07D11K-J	3.4 (.13)	1.3 (.05)
EV07D14K-J	3.5 (.14)	1.3 (.05)
EV07D17K-J	3.8 (.15)	1.4 (.06)
EV07D20K-J	3.4 (.13)	1.2 (.05)
EV07D25K-J	3.6 (.14)	1.3 (.05)
EV07D30K-J	3.8 (.15)	1.5 (.06)
EV07D35K-J	3.9 (.15)	1.6 (.06)
EV07D40K-J	4.0 (.16)	1.8 (.07)
EV07D50K-J	3.4 (.13)	1.2 (.05)
EV07D60K-J	3.6 (.14)	1.2 (.05)
EV07D75K-J	3.8 (.15)	1.3 (.05)
EV07D95K-J	4.0 (.16)	1.4 (.06)
EV07D120K-J	3.2 (.13)	1.4 (.05)
EV07D130K-J	3.4 (.13)	1.5 (.06)
EV07D140K-J	3.5 (.14)	1.5 (.06)

Part Number	E Max mm (in)	Off-set Dimension (a) ±1 (±0.04) mm (in)
EV07D150K-J	3.6 (.14)	1.6 (.06)
EV07D180K-J	3.8 (.15)	1.8 (.07)
EV07D195K-J	4.0 (.16)	1.6 (.06)
EV07D210K-J	4.2 (.17)	1.7 (.07)
EV07D230K-J	4.4 (.17)	1.8 (.07)
EV07D250K-J	4.6 (.18)	1.9 (.08)
EV07D275K-J	4.8 (.19)	2.0 (.08)
EV07D300K-J	5.0 (.20)	2.4 (.10)
EV07D320K-J	5.1 (.20)	2.0 (.09)
EV07D360K-J	5.4 (.20)	2.6 (.10)
EV07D390K-J	5.8 (.24)	2.6 (.10)
EV07D420K-J	6.0 (.24)	*3.0 (.12)
EV07D460K-J	6.2 (.24)	*3.3 (.13)
EV07D485K-J	6.4 (.25)	*3.4 (.13)
EV07D510K-J	6.8 (.27)	*3.5 (.14)

\* Parts rated ≥420VAC come standard with inline crimp for straight disk seating on PC boards. For these parts, the “a” dimension is not applicable. If ≥420VAC parts are required without inline crimp, please reference “Part Number System” position 9 and add suffix “N” then reference “a” dimension above.

## Standard Dimensions and Lead Modification Options (continued)

**E Max Dimensions for EV High Energy (-J) Series (5, 7, 10, 14 and 20mm) using standard epoxy coating. For flame retardant coating (suffix “s”) dimensions “E” & “a” add 10% (x1.10) as this coating is thicker.**

Dimensions are in mm (inches)

10mm

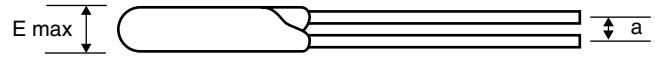

Part Number	E Max mm (in)	Off-set Dimension (a) ±1 (±0.04) mm (in)	Part Number	E Max mm (in)	Off-set Dimension (a) ±1 (±0.04) mm (in)
EV10D11K-J	3.8 (.15)	1.4 (.06)	EV10D195K-J	4.4 (.17)	1.8 (.07)
EV10D14K-J	3.9 (.15)	1.5 (.06)	EV10D210K-J	4.6 (.18)	1.9 (.08)
EV10D17K-J	4.2 (.17)	1.7 (.07)	EV10D230K-J	4.8 (.19)	2.0 (.08)
EV10D20K-J	3.8 (.15)	1.9 (.08)	EV10D250K-J	5.0 (.20)	2.1 (.08)
EV10D25K-J	4.0 (.16)	1.7 (.07)	EV10D275K-J	5.2 (.21)	2.1 (.08)
EV10D30K-J	4.2 (.17)	1.8 (.07)	EV10D300K-J	5.4 (.21)	2.6 (.10)
EV10D35K-J	4.3 (.17)	2.0 (.08)	EV10D320K-J	5.5 (.22)	2.6 (.10)
EV10D40K-J	4.4 (.17)	2.2 (.09)	EV10D360K-J	5.9 (.23)	2.8 (.10)
EV10D50K-J	3.8 (.15)	1.4 (.06)	EV10D390K-J	6.2 (.24)	3.1 (.12)
EV10D60K-J	4.0 (.16)	1.4 (.06)	EV10D420K-J	6.4 (.25)	*3.3 (.13)
EV10D75K-J	4.2 (.17)	1.5 (.06)	EV10D460K-J	6.6 (.26)	*3.5 (.14)
EV10D95K-J	4.4 (.17)	1.7 (.07)	EV10D485K-J	6.8 (.27)	*3.6 (.14)
EV10D120K-J	3.6 (.14)	1.6 (.06)	EV10D510K-J	7.2 (.28)	*3.8 (.15)
EV10D130K-J	3.8 (.15)	1.7 (.07)	EV10D550K-J	7.6 (.30)	*4.1 (.16)
EV10D140K-J	3.9 (.15)	1.8 (.07)	EV10D625K-J	8.0 (.32)	*4.4 (.17)
EV10D150K-J	4.0 (.16)	1.9 (.07)	EV10D680K-J	8.5 (.37)	*4.9 (.19)
EV10D180K-J	4.2 (.17)	2.0 (.08)			

\* Parts rated  $\geq 420\text{VAC}$  come standard with inline crimp for straight disk seating on PC boards. For these parts, the “a” dimension is not applicable. If  $\geq 420\text{VAC}$  parts are required without inline crimp, please reference “Part Number System” position 9 and add suffix “N” then reference “a” dimension above.

**Standard Dimensions and Lead Modification Options (continued)**

**E Max Dimensions for EV High Energy (-J) Series (5, 7, 10, 14 and 20mm) using standard epoxy coating. For flame retardant coating (suffix “s”) dimensions “E” & “a” add 10% (x1.10) as this coating is thicker.**

Dimensions are in mm (inches)

**14mm**

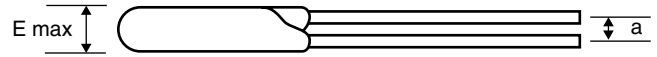

Part Number	E Max mm (in)	Off-set Dimension (a) ±1 (±0.04) mm (in)
EV14D11K-J	3.8 (.15)	1.4 (.06)
EV14D14K-J	3.9 (.15)	1.5 (.06)
EV14D17K-J	4.2 (.17)	1.7 (.07)
EV14D20K-J	3.8 (.15)	1.9 (.08)
EV14D25K-J	4.0 (.16)	1.7 (.07)
EV14D30K-J	4.2 (.17)	1.8 (.07)
EV14D35K-J	4.3 (.17)	2.0 (.08)
EV14D40K-J	4.4 (.17)	2.2 (.09)
EV14D50K-J	3.8 (.15)	1.4 (.06)
EV14D60K-J	4.0 (.16)	1.5 (.06)
EV14D75K-J	4.2 (.17)	1.5 (.06)
EV14D95K-J	4.4 (.17)	1.7 (.07)
EV14D120K-J	3.6 (.14)	1.7 (.07)
EV14D130K-J	3.8 (.15)	1.8 (.07)
EV14D140K-J	3.9 (.15)	1.9 (.08)
EV14D150K-J	4.0 (.16)	1.9 (.08)
EV14D180K-J	4.2 (.17)	2.0 (.08)

Part Number	E Max mm (in)	Off-set Dimension (a) ±1 (±0.04) mm (in)
EV14D195K-J	4.4 (.17)	2.0 (.08)
EV14D210K-J	4.6 (.18)	2.1 (.08)
EV14D230K-J	4.8 (.19)	2.0 (.09)
EV14D250K-J	5.0 (.20)	2.3 (.09)
EV14D275K-J	5.2 (.21)	2.3 (.09)
EV14D300K-J	5.4 (.21)	2.6 (.10)
EV14D320K-J	5.5 (.22)	2.6 (.10)
EV14D360K-J	5.9 (.23)	2.8 (.10)
EV14D390K-J	6.2 (.24)	3.1 (.12)
EV14D420K-J	6.4 (.25)	*3.3 (.13)
EV14D460K-J	6.6 (.26)	*3.5 (.14)
EV14D485K-J	6.8 (.27)	*3.6 (.14)
EV14D510K-J	7.2 (.28)	*3.8 (.15)
EV14D550K-J	7.6 (.30)	*4.0 (.16)
EV14D625K-J	8.0 (.32)	*4.4 (.18)
EV14D680K-J	8.5 (.37)	*4.9 (.19)

\* Parts rated ≥420VAC come standard with inline crimp for straight disk seating on PC boards. For these parts, the “a” dimension is not applicable. If ≥420VAC parts are required without inline crimp, please reference “Part Number System” position 9 and add suffix “N” then reference “a” dimension above.

**Standard Dimensions and Lead Modification Options (continued)**

**E Max Dimensions for EV High Energy (-J) Series (5, 7, 10, 14 and 20mm) using standard epoxy coating. For flame retardant coating (suffix “s”) dimensions “E” & “a” add 10% (x1.10) as this coating is thicker.**

Dimensions are in mm (inches)

**20mm**

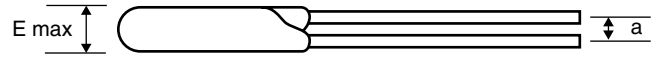

Part Number	E Max mm (in)	Off-set Dimension (a) ±1 (±0.04) mm (in)
EV20D11K-J	4.2 (.17)	1.5 (.06)
EV20D14K-J	4.3 (.17)	1.6 (.06)
EV20D17K-J	4.6 (.18)	1.8 (.07)
EV20D20K-J	4.2 (.17)	2.1 (.08)
EV20D25K-J	4.4 (.17)	2.1 (.08)
EV20D30K-J	4.6 (.18)	2.2 (.09)
EV20D35K-J	4.7 (.19)	2.2 (.09)
EV20D40K-J	4.8 (.19)	2.4 (.09)
EV20D50K-J	4.2 (.17)	1.5 (.06)
EV20D60K-J	4.4 (.17)	1.6 (.06)
EV20D75K-J	4.6 (.18)	1.6 (.06)
EV20D95K-J	4.8 (.19)	1.6 (.06)
EV20D120K-J	4.0 (.16)	1.8 (.07)
EV20D130K-J	4.2 (.07)	2.2 (.09)
EV20D140K-J	4.3 (.17)	2.3 (.09)
EV20D150K-J	4.4 (.17)	2.1 (.08)
EV20D180K-J	4.6 (.18)	2.3 (.09)

Part Number	E Max mm (in)	Off-set Dimension (a) ±1 (±0.04) mm (in)
EV20D195K-J	4.8 (.19)	2.2 (.09)
EV20D210K-J	5.0 (.20)	2.3 (.09)
EV20D230K-J	5.2 (.21)	2.4 (.09)
EV20D250K-J	5.4 (.21)	2.5 (.10)
EV20D275K-J	5.6 (.22)	2.5 (.10)
EV20D300K-J	5.9 (.23)	2.9 (.11)
EV20D320K-J	6.0 (.24)	2.8 (.10)
EV20D360K-J	6.5 (.26)	3.1 (.12)
EV20D390K-J	6.9 (.27)	3.3 (.13)
EV20D420K-J	7.0 (.28)	*3.5 (.14)
EV20D460K-J	7.2 (.28)	*3.8 (.15)
EV20D485K-J	7.4 (.29)	*3.9 (.15)
EV20D510K-J	7.8 (.31)	*4.0 (.16)
EV20D550K-J	8.2 (.32)	*4.4 (.17)
EV20D625K-J	8.7 (.34)	*4.7 (.19)
EV20D680K-J	9.2 (.36)	*5.2 (.20)

\* Parts rated ≥420VAC come standard with inline crimp for straight disk seating on PC boards. For these parts, the “a” dimension is not applicable. If ≥420VAC parts are required without inline crimp, please reference “Part Number System” position 9 and add suffix “N” then reference “a” dimension above.



**Standard Dimensions and Lead Modification Options (continued)**

**E Max Dimensions for EV Ultra High Energy (-H) Series (14 and 20mm) using standard epoxy coating. For flame retardant coating (suffix “s”) dimensions “E” & “a” add 10% (x1.10) as this coating is thicker.**

Dimensions are in mm (inches)

**14mm**

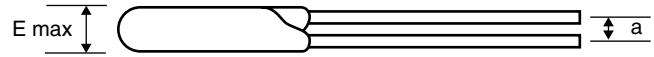

Part Number	E Max mm (in)	Off-set Dimension (a) ±1 (±0.04) mm (in)
EV14D120K-H	3.6 (.14)	1.7 (.07)
EV14D130K-H	3.8 (.15)	1.8 (.07)
EV14D140K-H	3.9 (.15)	1.9 (.08)
EV14D150K-H	4.0 (.16)	1.9 (.08)
EV14D180K-H	4.2 (.17)	2.0 (.08)
EV14D195K-H	4.4 (.17)	2.0 (.08)
EV14D210K-H	4.6 (.18)	2.1 (.08)
EV14D230K-H	4.8 (.19)	2.3 (.09)
EV14D250K-H	5.0 (.20)	2.3 (.09)
EV14D275K-H	5.2 (.21)	2.3 (.09)
EV14D300K-H	5.4 (.21)	2.6 (.10)

Part Number	E Max mm (in)	Off-set Dimension (a) ±1 (±0.04) mm (in)
EV14D320K-H	5.5 (.22)	2.6 (.10)
EV14D360K-H	5.9 (.23)	2.8 (.10)
EV14D390K-H	6.2 (.24)	3.1 (.12)
EV14D420K-H	6.4 (.25)	*3.3 (.13)
EV14D460K-H	6.6 (.26)	*3.5 (.14)
EV14D485K-H	6.8 (.27)	*3.6 (.14)
EV14D510K-H	7.2 (.28)	*3.8 (.15)
EV14D550K-H	7.6 (.30)	*4.0 (.16)
EV14D625K-H	8.0 (.32)	*4.4 (.18)
EV14D680K-H	8.5 (.37)	*4.9 (.19)

**20mm**

Part Number	E Max mm (in)	Off-set Dimension (a) ±1 (±0.04) mm (in)
EV20D120K-H	4.0 (.16)	2.1 (.08)
EV20D130K-H	4.2 (.07)	2.2 (.09)
EV20D140K-H	4.3 (.17)	2.3 (.09)
EV20D150K-H	4.4 (.17)	2.1 (.08)
EV20D180K-H	4.6 (.18)	2.3 (.09)
EV20D195K-H	4.8 (.19)	2.2 (.09)
EV20D210K-H	5.0 (.20)	2.3 (.09)
EV20D230K-H	5.2 (.21)	2.4 (.09)
EV20D250K-H	5.4 (.21)	2.5 (.10)
EV20D275K-H	5.6 (.22)	2.5 (.10)
EV20D300K-H	5.9 (.23)	2.9 (.11)

Part Number	E Max mm (in)	Off-set Dimension (a) ±1 (±0.04) mm (in)
EV20D320K-H	6.0 (.24)	2.8 (.10)
EV20D360K-H	6.5 (.26)	3.1 (.12)
EV20D390K-H	6.9 (.27)	3.3 (.13)
EV20D420K-H	7.0 (.28)	*3.5 (.14)
EV20D460K-H	7.2 (.28)	*3.8 (.15)
EV20D485K-H	7.4 (.29)	*3.9 (.15)
EV20D510K-H	7.8 (.31)	*4.0 (.16)
EV20D550K-H	8.2 (.32)	*4.4 (.17)
EV20D625K-H	8.7 (.34)	*4.7 (.19)
EV20D680K-H	9.2 (.36)	*5.2 (.20)

\* Parts rated ≥420VAC come standard with inline crimp for straight disk seating on PC boards. For these parts, the “a” dimension is not applicable. If ≥420VAC parts are required without inline crimp, please reference “Part Number System” position 9 and add suffix “N” then reference “a” dimension above.

**Standard Dimensions and Lead Modification Options (continued)**

**E Max Dimensions for EV Standard Wire Lead using standard epoxy coating.**

Dimensions are in mm (inches)

**22mm**

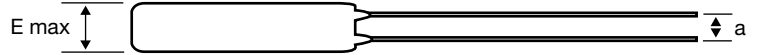

Part Number	E Max mm (in)	Off-set Dimension (a) ±1 (±0.04) mm (in)	Part Number	E Max mm (in)	Off-set Dimension (a) ±1 (±0.04) mm (in)
EV22D17KW	5.33 (0.210)	1.79 (0.071)	EV22D275KW	7.06 (0.278)	3.66 (0.144)
EV22D20KW	5.50 (0.217)	2.10 (0.083)	EV22D300KW	7.29 (0.287)	3.89 (0.153)
EV22D25KW	5.67 (0.223)	2.27 (0.089)	EV22D320KW	7.59 (0.299)	4.19 (0.165)
EV22D30KW	5.50 (0.217)	2.10 (0.083)	EV22D360KW	7.82 (0.308)	4.42 (0.174)
EV22D35KW	5.68 (0.224)	2.28 (0.090)	EV22D390KW	8.21 (0.323)	4.81 (0.189)
EV22D40KW	5.92 (0.233)	2.52 (0.099)	EV22D420KW	8.59 (0.338)	5.19 (0.204)
EV22D50KW	5.27 (0.207)	1.87 (0.074)	EV22D460KW	9.00 (0.354)	5.60 (0.220)
EV22D60KW	5.45 (0.215)	2.05 (0.081)	EV22D485KW	9.18 (0.361)	5.78 (0.227)
EV22D120KW	5.82 (0.229)	2.42 (0.095)	EV22D510KW	9.41 (0.370)	6.01 (0.237)
EV22D130KW	5.96 (0.235)	2.56 (0.101)	EV22D550KW	9.94 (0.391)	6.54 (0.257)
EV22D140KW	6.11 (0.241)	2.71 (0.107)	EV22D575KW	10.18 (0.401)	6.78 (0.267)
EV22D150KW	6.25 (0.246)	2.85 (0.112)	EV22D625KW	10.53 (0.415)	7.10 (0.280)
EV22D180KW	6.46 (0.254)	3.06 (0.121)	EV22D680KW	11.12 (0.438)	7.69 (0.303)
EV22D195KW	6.29 (0.248)	2.89 (0.114)	EV22D750KW	11.71 (0.461)	8.31 (0.327)
EV22D210KW	6.47 (0.255)	3.07 (0.121)	EV22D850KW	12.88 (0.507)	9.48 (0.373)
EV22D230KW	6.65 (0.262)	3.25 (0.128)	EV22D1000KW	14.06 (0.553)	10.69 (0.421)
EV22D250KW	6.82 (0.269)	3.42 (0.135)			

**Standard Dimensions and Lead Modification Options (continued)**

**E Max Dimensions for EV Standard Tab Lead using standard epoxy coating.**

Dimensions are in mm (inches)

**22mm**

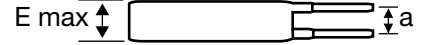

Part Number	E Max mm (in)	Off-set Dimension (a) ±1 (±0.04) mm (in)	Part Number	E Max mm (in)	Off-set Dimension (a) ±1 (±0.04) mm (in)
EV22D14K	3.89 (0.153)	1.09 (0.043)	EV22D230K	5.55 (0.219)	2.65 (0.104)
EV22D17K	4.03 (0.159)	1.23 (0.048)	EV22D250K	5.72 (0.225)	2.82 (0.111)
EV22D20K	4.20 (0.165)	1.40 (0.055)	EV22D275K	5.96 (0.235)	3.06 (0.120)
EV22D25K	4.37 (0.172)	1.57 (0.062)	EV22D300K	6.19 (0.244)	3.29 (0.130)
EV22D30K	4.20 (0.165)	1.40 (0.055)	EV22D320K	6.49 (0.256)	3.59 (0.141)
EV22D35K	4.38 (0.172)	1.58 (0.062)	EV22D360K	6.72 (0.265)	3.82 (0.150)
EV22D40K	4.62 (0.182)	1.82 (0.072)	EV22D390K	7.11 (0.280)	4.21 (0.166)
EV22D50K	3.97 (0.156)	1.17 (0.046)	EV22D420K	7.49 (0.295)	4.59 (0.181)
EV22D60K	4.15 (0.163)	1.35 (0.053)	EV22D460K	7.90 (0.311)	5.00 (0.197)
EV22D75K	4.34 (0.171)	1.54 (0.061)	EV22D485K	8.08 (0.318)	5.18 (0.204)
EV22D95K	4.31 (0.170)	1.51 (0.059)	EV22D510K	8.31 (0.327)	5.41 (0.213)
EV22D120K	4.52 (0.178)	1.72 (0.068)	EV22D550K	8.84 (0.348)	5.94 (0.234)
EV22D130K	4.66 (0.183)	1.86 (0.073)	EV22D575K	9.08 (0.357)	6.18 (0.243)
EV22D140K	4.81 (0.189)	2.01 (0.079)	EV22D625K	9.40 (0.370)	6.50 (0.256)
EV22D150K	4.95 (0.195)	2.15 (0.085)	EV22D680K	9.99 (0.393)	7.09 (0.279)
EV22D180K	5.16 (0.203)	2.36 (0.093)	EV22D750K	10.61 (0.418)	7.71 (0.304)
EV22D195K	5.19 (0.204)	2.29 (0.090)	EV22D850K	11.78 (0.464)	8.88 (0.350)
EV22D210K	5.37 (0.211)	2.47 (0.097)	EV22D1000K	12.46 (0.491)	10.09 (0.397)

**Standard Dimensions and Lead Modification Options (continued)**

**E Max Dimensions for EV Standard Tab Lead using standard epoxy coating.**

Dimensions are in mm (inches)

**34mm**

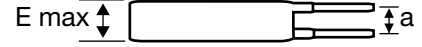

Part Number	E Max mm (in)	Off-set Dimension (a) ±1 (±0.04) mm (in)	Part Number	E Max mm (in)	Off-set Dimension (a) ±1 (±0.04) mm (in)
EV34D30K	4.4 (0.173)	1.5 (0.059)	EV34D275K	6.16 (0.243)	3.16 (0.124)
EV34D35K	4.58 (0.180)	1.68 (0.066)	EV34D300K	6.39 (0.252)	3.39 (0.133)
EV34D40K	4.82 (0.191)	1.92 (0.076)	EV34D320K	6.69 (0.263)	3.69 (0.145)
EV34D50K	4.17 (0.164)	1.27 (0.050)	EV34D360K	6.92 (0.272)	3.92 (0.154)
EV34D60K	4.35 (0.171)	1.45 (0.057)	EV34D390K	7.31 (0.288)	4.31 (0.170)
EV34D75K	4.54 (0.179)	1.64 (0.065)	EV34D420K	7.69 (0.303)	4.69 (0.185)
EV34D95K	4.51 (0.178)	1.61 (0.063)	EV34D460K	8.10 (0.319)	5.10 (0.201)
EV34D120K	4.72 (0.186)	1.82 (0.072)	EV34D485K	8.28 (0.326)	5.28 (0.208)
EV34D130K	4.86 (0.191)	1.96 (0.077)	EV34D510K	8.51 (0.335)	5.51 (0.217)
EV34D140K	5.01 (0.197)	2.11 (0.083)	EV34D550K	9.04 (0.356)	6.04 (0.238)
EV34D150K	5.15 (0.203)	2.25 (0.089)	EV34D575K	9.28 (0.365)	6.28 (0.247)
EV34D180K	5.36 (0.211)	2.46 (0.097)	EV34D625K	9.50 (0.374)	6.60 (0.260)
EV34D195K	5.39 (0.212)	2.39 (0.094)	EV34D680K	10.19 (0.401)	7.19 (0.283)
EV34D210K	5.57 (0.219)	2.57 (0.101)	EV34D750K	10.81 (0.426)	7.81 (0.307)
EV34D230K	5.75 (0.226)	2.75 (0.108)	EV34D850K	11.98 (0.472)	8.98 (0.354)
EV34D250K	5.92 (0.233)	2.92 (0.115)	EV34D1000K	12.66 (0.498)	9.66 (0.380)

**Standard Dimensions and Lead Modification Options (continued)**

**E Max Dimensions for EV Ultra High Energy (-H) Series – Tab Lead using standard epoxy coating.**

Dimensions are in mm (inches)

**34mm**

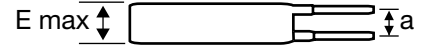

Part Number	E Max mm (in)	Off-set Dimension (a) ±1 (±0.04) mm (in)
EV34D60K-H	4.35 (0.171)	1.45 (0.057)
EV34D75K-H	4.54 (0.179)	1.64 (0.065)
EV34D130K-H	5.06 (0.199)	2.06 (0.081)
EV34D140K-H	5.21 (0.205)	2.21 (0.087)
EV34D150K-H	5.35 (0.211)	2.35 (0.093)
EV34D180K-H	5.56 (0.219)	2.56 (0.101)
EV34D195K-H	5.78 (0.228)	2.78 (0.109)
EV34D210K-H	5.99 (0.236)	2.99 (0.118)
EV34D230K-H	6.21 (0.244)	3.21 (0.126)

Part Number	E Max mm (in)	Off-set Dimension (a) ±1 (±0.04) mm (in)
EV34D250K-H	6.42 (0.253)	3.42 (0.135)
EV34D275K-H	6.71 (0.264)	3.71 (0.146)
EV34D300K-H	6.99 (0.275)	3.99 (0.157)
EV34D320K-H	7.35 (0.289)	4.35 (0.171)
EV34D360K-H	7.64 (0.301)	4.64 (0.183)
EV34D390K-H	8.10 (0.319)	5.1 (0.201)
EV34D420K-H	8.56 (0.337)	5.56 (0.219)

**Standard Dimensions and Lead Modification Options (continued)**

**E Max Dimensions for EV Pin Type Series – Tab Lead using standard epoxy coating.**

Dimensions are in mm (inches)

**22mm**

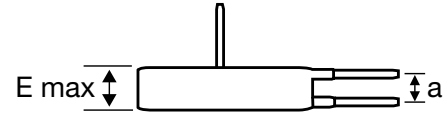

Part Number	E Max mm (in)	Off-set Dimension (a) ±1 (±0.04) mm (in)
EV22D14KP	3.89 (0.153)	1.09 (0.043)
EV22D17KP	4.03 (0.159)	1.23 (0.048)
EV22D20KP	4.20 (0.165)	1.40 (0.055)
EV22D25KP	4.37 (0.172)	1.57 (0.062)
EV22D30KP	4.20 (0.165)	1.40 (0.055)
EV22D35KP	4.38 (0.172)	1.58 (0.062)
EV22D40KP	4.62 (0.182)	1.82 (0.072)
EV22D50KP	3.97 (0.156)	1.17 (0.046)
EV22D60KP	4.15 (0.163)	1.35 (0.053)
EV22D75KP	4.34 (0.171)	1.54 (0.061)
EV22D95KP	4.31 (0.170)	1.51 (0.059)
EV22D120KP	4.52 (0.178)	1.72 (0.068)
EV22D130KP	4.66 (0.183)	1.86 (0.073)
EV22D140KP	4.81 (0.189)	2.01 (0.079)
EV22D150KP	4.95 (0.195)	2.15 (0.085)
EV22D180KP	5.16 (0.203)	2.36 (0.093)
EV22D195KP	5.19 (0.204)	2.29 (0.090)
EV22D210KP	5.37 (0.211)	2.47 (0.097)
EV22D230KP	5.55 (0.219)	2.65 (0.104)

Part Number	E Max mm (in)	Off-set Dimension (a) ±1 (±0.04) mm (in)
EV22D250KP	5.72 (0.225)	2.82 (0.111)
EV22D275KP	5.96 (0.235)	3.06 (0.120)
EV22D300KP	6.19 (0.244)	3.29 (0.130)
EV22D320KP	6.49 (0.256)	3.59 (0.141)
EV22D360KP	6.72 (0.265)	3.82 (0.150)
EV22D390KP	7.11 (0.280)	4.21 (0.166)
EV22D420KP	7.49 (0.295)	4.59 (0.181)
EV22D460KP	7.90 (0.311)	5.00 (0.197)
EV22D485KP	8.08 (0.318)	5.18 (0.204)
EV22D510KP	8.31 (0.327)	5.41 (0.213)
EV22D550KP	8.84 (0.348)	5.94 (0.234)
EV22D575KP	9.08 (0.357)	6.18 (0.243)
EV22D625KP	9.40 (0.370)	6.50 (0.256)
EV22D680KP	9.99 (0.393)	7.09 (0.279)
EV22D750KP	10.61 (0.418)	7.71 (0.304)
EV22D850KP	11.78 (0.464)	8.88 (0.350)
EV22D1000KP	12.46 (0.491)	10.09 (0.397)
EV22D1100KP	13.57 (0.534)	1.26 (0.443)

**Standard Dimensions and Lead Modification Options (continued)**

**E Max Dimensions for EV Pin Type Series – Tab Lead using standard epoxy coating.**

Dimensions are in mm (inches)

**34mm**

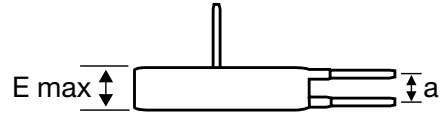

Part Number	E Max mm (in)	Off-set Dimension (a) ±1 (±0.04) mm (in)
EV34D30KP	4.4 (0.173)	1.5 (0.059)
EV34D35KP	4.58 (0.180)	1.68 (0.066)
EV34D40KP	4.82 (0.191)	1.92 (0.076)
EV34D50KP	4.17 (0.164)	1.27 (0.050)
EV34D60KP	4.35 (0.171)	1.45 (0.057)
EV34D75KP	4.54 (0.179)	1.64 (0.065)
EV34D95KP	4.51 (0.178)	1.61 (0.063)
EV34D120KP	4.72 (0.186)	1.82 (0.072)
EV34D130KP	4.86 (0.191)	1.96 (0.077)
EV34D140KP	5.01 (0.197)	2.11 (0.083)
EV34D150KP	5.15 (0.203)	2.25 (0.089)
EV34D180KP	5.36 (0.211)	2.46 (0.097)
EV34D195KP	5.39 (0.212)	2.39 (0.094)
EV34D210KP	5.57 (0.219)	2.57 (0.101)
EV34D230KP	5.75 (0.226)	2.75 (0.108)
EV34D250KP	5.92 (0.233)	2.92 (0.115)

Part Number	E Max mm (in)	Off-set Dimension (a) ±1 (±0.04) mm (in)
EV34D275KP	6.16 (0.243)	3.16 (0.124)
EV34D300KP	6.39 (0.252)	3.39 (0.133)
EV34D320KP	6.69 (0.263)	3.69 (0.145)
EV34D360KP	6.92 (0.272)	3.92 (0.154)
EV34D390KP	7.31 (0.288)	4.31 (0.170)
EV34D420KP	7.69 (0.303)	4.69 (0.185)
EV34D460KP	8.10 (0.319)	5.10 (0.201)
EV34D485KP	8.28 (0.326)	5.28 (0.208)
EV34D510KP	8.51 (0.335)	5.51 (0.217)
EV34D550KP	9.04 (0.356)	6.04 (0.238)
EV34D575KP	9.28 (0.365)	6.28 (0.247)
EV34D625KP	9.50 (0.374)	6.60 (0.260)
EV34D680KP	10.19 (0.401)	7.19 (0.283)
EV34D750KP	10.81 (0.426)	7.81 (0.307)
EV34D850KP	11.98 (0.472)	8.98 (0.354)
EV34D1000KP	12.66 (0.498)	9.66 (0.380)

**Standard Dimensions and Lead Modification Options (continued)**

**E Max Dimensions for EV Uncoated Disk Series – No Leads**

Dimensions are in mm (inches)

22mm

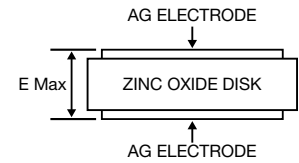

Part Number	E Max mm (in)	Off-set Dimension (a) ±1 (±0.04) mm (in)	Part Number	E Max mm (in)	Off-set Dimension (a) ±1 (±0.04) mm (in)
EV22D14KA	0.71 (0.028)	N/A	EV22D230KA	2.15 (0.085)	N/A
EV22D17KA	0.86 (0.034)	N/A	EV22D250KA	2.32 (0.091)	N/A
EV22D20KA	1.03 (0.041)	N/A	EV22D275KA	2.56 (0.101)	N/A
EV22D25KA	1.20 (0.047)	N/A	EV22D300KA	2.79 (0.110)	N/A
EV22D30KA	1.00 (0.039)	N/A	EV22D320KA	3.09 (0.122)	N/A
EV22D35KA	1.18 (0.046)	N/A	EV22D360KA	3.32 (0.131)	N/A
EV22D40KA	1.42 (0.056)	N/A	EV22D390KA	3.71 (0.146)	N/A
EV22D50KA	0.77 (0.030)	N/A	EV22D420KA	4.09 (0.161)	N/A
EV22D60KA	0.96 (0.038)	N/A	EV22D460KA	4.50 (0.177)	N/A
EV22D75KA	1.14 (0.045)	N/A	EV22D485KA	4.66 (0.184)	N/A
EV22D95KA	1.11 (0.044)	N/A	EV22D510KA	4.91 (0.193)	N/A
EV22D120KA	1.32 (0.052)	N/A	EV22D550KA	5.44 (0.214)	N/A
EV22D130KA	1.46 (0.058)	N/A	EV22D575KA	5.68 (0.223)	N/A
EV22D140KA	1.61 (0.063)	N/A	EV22D625KA	6.00 (0.236)	N/A
EV22D150KA	1.75 (0.069)	N/A	EV22D680KA	6.59 (0.259)	N/A
EV22D180KA	1.96 (0.077)	N/A	EV22D750KA	7.21 (0.284)	N/A
EV22D195KA	1.79 (0.071)	N/A	EV22D850KA	8.38 (0.330)	N/A
EV22D210KA	1.97 (0.078)	N/A	EV22D1000KA	9.06 (0.357)	N/A



## Standard Dimensions and Lead Modification Options (continued)

### E Max Dimensions for EV Uncoated Disk Series – No Leads

Dimensions are in mm (inches)

34mm

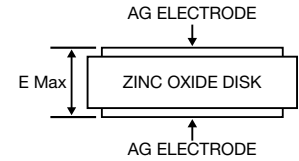

Part Number	E Max mm (in)	Off-set Dimension (a) ±1 (±0.04) mm (in)	Part Number	E Max mm (in)	Off-set Dimension (a) ±1 (±0.04) mm (in)
EV34D30KA	1.00 (0.039)	N/A	EV34D275KA	2.56 (0.101)	N/A
EV34D35KA	1.18 (0.046)	N/A	EV34D300KA	2.79 (0.110)	N/A
EV34D40KA	1.42 (0.056)	N/A	EV34D320KA	3.09 (0.122)	N/A
EV34D50KA	0.77 (0.030)	N/A	EV34D360KA	3.32 (0.131)	N/A
EV34D60KA	0.96 (0.038)	N/A	EV34D390KA	3.71 (0.146)	N/A
EV34D75KA	1.14 (0.045)	N/A	EV34D420KA	4.09 (0.161)	N/A
EV34D95KA	1.11 (0.044)	N/A	EV34D460KA	4.50 (0.177)	N/A
EV34D120KA	1.32 (0.052)	N/A	EV34D485KA	4.68 (0.184)	N/A
EV34D130KA	1.46 (0.058)	N/A	EV34D510KA	4.91 (0.193)	N/A
EV34D140KA	1.61 (0.063)	N/A	EV34D550KA	5.44 (0.214)	N/A
EV34D150KA	1.75 (0.069)	N/A	EV34D575KA	5.68 (0.223)	N/A
EV34D180KA	1.96 (0.077)	N/A	EV34D625KA	6.00 (0.236)	N/A
EV34D195KA	1.79 (0.071)	N/A	EV34D680KA	6.59 (0.259)	N/A
EV34D210KA	1.97 (0.078)	N/A	EV34D750KA	7.21 (0.284)	N/A
EV34D230KA	2.15 (0.085)	N/A	EV34D850KA	8.38 (0.330)	N/A
EV34D250KA	2.32 (0.091)	N/A	EV34D1000KA	9.06 (0.357)	N/A

**EV Standard Series – Electrical Characteristics**

5mm

Part Number	Maximum Continuous Rated Voltage		Rated Single Pulse Transient		Varistor Voltage @1mA DC		Maximum Clamping Voltage @Test Current 8/20µs		Typical Capacitance @1KHZ 25°C
			Energy	Peak					
	AC RMS Volts	DC Volts	8/20µs (joules)	8/20µs Amps	Min Volts	Max Volts	Volts	Amps	pF
EV05D11K	11	14	0.4	125	16	20	40	1	1500
EV05D14K	14	18	0.5	125	20	24	48	1	1260
EV05D17K	17	22	0.6	125	24	30	60	1	1050
EV05D20K	20	26	0.8	125	30	36	73	1	850
EV05D25K	25	31	0.9	125	35	43	86	1	600
EV05D30K	30	38	1.1	125	42	52	104	1	500
EV05D35K	35	45	1.3	125	50	62	123	1	400
EV05D40K	40	56	1.6	125	61	75	150	1	360
EV05D50K	50	65	2.5	500	74	90	145	5	480
EV05D60K	60	85	3.0	500	90	110	175	5	420
EV05D75K	75	100	4.0	500	108	132	210	5	360
EV05D95K	95	125	4.8	500	135	165	260	5	280
EV05D120K	120	150	5.9	500	162	198	320	5	200
EV05D130K	130	170	6.5	500	185	225	355	5	160
EV05D140K	140	180	7.0	500	198	242	380	5	110
EV05D150K	150	200	8.0	500	216	264	415	5	105
EV05D180K	180	225	9.0	500	243	297	475	5	100
EV05D195K	195	250	9.0	500	270	330	520	5	95
EV05D210K	210	275	10	500	297	363	570	5	90
EV05D230K	230	300	10	500	324	396	620	5	85
EV05D250K	250	320	12	500	351	429	675	5	80
EV05D275K	275	350	13	500	387	473	745	5	70
EV05D300K	300	385	15	500	423	517	810	5	60
EV05D320K	320	415	16	500	459	561	845	5	55
EV05D360K	360	460	16	500	504	616	925	5	50

**EV Standard Series – Electrical Characteristics**

7mm

Part Number	Maximum Continuous Rated Voltage		Rated Single Pulse Transient		Varistor Voltage @1mA DC		Maximum Clamping Voltage @Test Current 8/20µs		Typical Capacitance @1KHZ 25°C
			Energy	Peak					
	AC RMS Volts	DC Volts	8/20µs (joules)	8/20µs Amps	Min Volts	Max Volts	Volts	Amps	pF
EV07D11K	11	14	0.9	250	16	20	36	2.5	2900
EV07D14K	14	18	1.1	250	20	24	43	2.5	2400
EV07D17K	17	22	1.4	250	24	30	53	2.5	1800
EV07D20K	20	26	1.7	250	30	36	65	2.5	1500
EV07D25K	25	31	2.1	250	35	43	77	2.5	1230
EV07D30K	30	38	2.5	250	42	52	93	2.5	950
EV07D35K	35	45	3.1	250	50	62	110	2.5	890
EV07D40K	40	56	3.6	250	61	75	135	2.5	850
EV07D50K	50	65	6.0	1200	74	90	135	10	930
EV07D60K	60	85	7.0	1200	90	110	165	10	860
EV07D75K	75	100	8.0	1200	108	132	200	10	670
EV07D95K	95	125	10	1200	135	165	250	10	490
EV07D120K	120	150	12	1200	162	198	300	10	330
EV07D130K	130	170	13	1200	185	225	340	10	240
EV07D140K	140	180	14	1200	198	242	360	10	190
EV07D150K	150	200	15	1200	216	264	395	10	165
EV07D180K	180	225	18	1200	243	297	455	10	150
EV07D195K	195	250	20	1200	270	330	500	10	140
EV07D210K	210	275	23	1200	297	363	550	10	130
EV07D230K	230	300	25	1200	324	396	595	10	125
EV07D250K	250	320	25	1200	351	429	650	10	115
EV07D275K	275	350	28	1200	387	473	710	10	110
EV07D300K	300	385	30	1200	423	517	775	10	100
EV07D320K	320	415	30	1200	459	561	845	10	90
EV07D360K	360	460	30	1200	504	616	925	10	85
EV07D390K	390	505	33	1200	558	682	1025	10	80
EV07D420K	420	560	33	1200	612	748	1120	10	75
EV07D460K	460	620	36	1200	675	825	1240	10	70
EV07D485K	485	640	36	1200	702	858	1290	10	70
EV07D510K	510	675	39	1200	738	902	1355	10	60

**EV Standard Series – Electrical Characteristics**

10mm

Part Number	Maximum Continuous Rated Voltage		Rated Single Pulse Transient		Varistor Voltage @1mA DC		Maximum Clamping Voltage @Test Current 8/20µs		Typical Capacitance @1KHZ 25°C
			Energy	Peak					
	AC RMS Volts	DC Volts	8/20µs (joules)	8/20µs Amps	Min Volts	Max Volts	Volts	Amps	pF
EV10D11K	11	14	2.1	500	16	20	36	5	6000
EV10D14K	14	18	2.5	500	20	24	43	5	5000
EV10D17K	17	22	3.0	500	24	30	53	5	4000
EV10D20K	20	26	4.0	500	30	36	65	5	3500
EV10D25K	25	31	4.6	500	35	43	77	5	3100
EV10D30K	30	38	6.0	500	42	52	93	5	2800
EV10D35K	35	45	7.0	500	50	62	110	5	2400
EV10D40K	40	56	8.0	500	61	75	135	5	2200
EV10D50K	50	65	12	2500	74	90	135	25	2100
EV10D60K	60	85	15	2500	90	110	165	25	1700
EV10D75K	75	100	18	2500	108	132	200	25	1500
EV10D95K	95	125	22	2500	135	165	250	25	1300
EV10D120K	120	150	27	2500	162	198	300	25	470
EV10D130K	130	170	30	2500	185	225	340	25	430
EV10D140K	140	180	32	2500	198	242	360	25	390
EV10D150K	150	200	35	2500	216	264	395	25	360
EV10D180K	180	225	40	2500	243	297	455	25	330
EV10D195K	195	250	40	2500	270	330	500	25	290
EV10D210K	210	275	43	2500	297	363	550	25	280
EV10D230K	230	300	47	2500	324	396	595	25	260
EV10D250K	250	320	60	2500	351	429	650	25	240
EV10D275K	275	350	65	2500	387	473	710	25	220
EV10D300K	300	385	70	2500	423	517	775	25	200
EV10D320K	320	415	70	2500	459	561	845	25	190
EV10D360K	360	460	70	2500	504	616	825	25	180
EV10D390K	390	505	70	2500	558	682	1025	25	160
EV10D420K	420	560	70	2500	612	748	1120	25	140
EV10D460K	460	615	75	2500	675	825	1240	25	130
EV10D485K	485	640	80	2500	702	858	1290	25	130
EV10D510K	510	670	85	2500	738	902	1355	25	130
EV10D550K	550	745	93	2500	819	1001	1500	25	120
EV10D625K	625	825	102	2500	900	1100	1650	25	100
EV10D680K	680	895	115	2500	990	1210	1815	25	90

**EV Standard Series – Electrical Characteristics**

14mm

Part Number	Maximum Continuous Rated Voltage		Rated Single Pulse Transient		Varistor Voltage @1mA DC		Maximum Clamping Voltage @Test Current 8/20µs		Typical Capacitance @1KHZ 25°C
			Energy	Peak					
	AC RMS Volts	DC Volts	8/20µs (joules)	8/20µs Amps	Min Volts	Max Volts	Volts	Amps	pF
EV14D11K	11	14	4.0	1000	16	20	36	10	15000
EV14D14K	14	18	5.0	1000	20	24	43	10	12000
EV14D17K	17	22	6.0	1000	24	30	53	10	8500
EV14D20K	20	26	8.0	1000	30	36	65	10	7200
EV14D25K	25	31	9.0	1000	35	43	77	10	6300
EV14D30K	30	38	10	1000	42	52	93	10	5500
EV14D35K	35	45	11	1000	50	62	110	10	4800
EV14D40K	40	56	14	1000	61	75	135	10	4000
EV14D50K	50	65	22	4500	74	90	135	50	3300
EV14D60K	60	85	28	4500	90	110	165	50	3400
EV14D75K	75	100	32	4500	108	132	200	50	3100
EV14D95K	95	125	40	4500	135	165	250	50	3000
EV14D120K	120	150	50	4500	162	198	300	50	1030
EV14D130K	130	170	57	4500	185	225	340	50	970
EV14D140K	140	180	60	4500	198	242	360	50	840
EV14D150K	150	200	63	4500	216	264	395	50	710
EV14D180K	180	225	70	4500	243	297	455	50	650
EV14D195K	195	250	77	4500	270	330	500	50	600
EV14D210K	210	275	85	4500	297	363	550	50	550
EV14D230K	230	300	93	4500	324	396	595	50	530
EV14D250K	250	320	100	4500	351	429	650	50	500
EV14D275K	275	350	115	4500	387	473	710	50	480
EV14D300K	300	385	125	4500	423	517	775	50	440
EV14D320K	320	415	125	4500	459	561	845	50	390
EV14D360K	360	460	125	4500	504	616	825	50	360
EV14D390K	390	505	125	4500	558	682	1025	50	320
EV14D420K	420	560	130	4500	612	748	1120	50	300
EV14D460K	460	615	143	4500	675	825	1240	50	280
EV14D485K	485	640	148	4500	702	858	1290	50	250
EV14D510K	510	670	157	4500	738	902	1355	50	230
EV14D550K	550	745	175	4500	819	1001	1500	50	200
EV14D625K	625	825	190	4500	900	1100	1650	50	180
EV14D680K	680	895	213	4500	990	1210	1815	50	150
EV14D750K	750	990	213	4500	1080	1320	1980	50	150
EV14D1100K	1100	1465	250	4500	1620	1980	2970	50	100

**EV Standard Series – Electrical Characteristics**

20mm

Part Number	Maximum Continuous Rated Voltage		Rated Single Pulse Transient		Varistor Voltage @1mA DC		Maximum Clamping Voltage @Test Current 8/20µs		Typical Capacitance @1KHZ 25°C
			Energy	Peak					
	AC RMS Volts	DC Volts	8/20µs (joules)	8/20µs Amps	Min Volts	Max Volts	Volts	Amps	pF
EV20D11K	11	14	11	2000	16	20	36	20	27000
EV20D14K	14	18	14	2000	20	24	43	20	20000
EV20D17K	17	22	16	2000	24	30	53	20	15000
EV20D20K	20	26	23	2000	30	36	65	20	12200
EV20D25K	25	31	26	2000	35	43	77	20	10000
EV20D30K	30	38	30	2000	42	52	93	20	9350
EV20D35K	35	45	41	2000	50	62	110	20	8000
EV20D40K	40	56	46	2000	61	75	135	20	6800
EV20D50K	50	65	38	6500	74	90	135	100	5800
EV20D60K	60	85	45	6500	90	110	165	100	3800
EV20D75K	75	100	55	6500	108	132	200	100	3000
EV20D95K	95	125	70	6500	135	165	250	100	2600
EV20D120K	120	150	85	10000	162	198	300	100	2400
EV20D130K	130	170	95	10000	185	225	340	100	1800
EV20D140K	140	180	100	10000	198	242	360	100	1500
EV20D150K	150	200	120	10000	216	264	395	100	1400
EV20D180K	180	225	127	10000	243	297	455	100	1350
EV20D195K	195	250	136	10000	270	330	500	100	1300
EV20D210K	210	275	150	10000	297	363	550	100	1250
EV20D230K	230	300	163	10000	324	396	595	100	1180
EV20D250K	250	320	180	10000	351	429	650	100	1100
EV20D275K	275	350	190	10000	387	473	710	100	1050
EV20D300K	300	385	220	10000	423	517	775	100	1000
EV20D320K	320	415	222	10000	459	561	845	100	970
EV20D360K	360	460	226	10000	504	616	825	100	950
EV20D390K	390	505	228	10000	558	682	1025	100	900
EV20D420K	420	560	230	10000	612	748	1120	100	850
EV20D460K	460	615	255	10000	675	825	1240	100	750
EV20D485K	485	640	265	10000	702	858	1290	100	700
EV20D510K	510	670	282	10000	738	902	1355	100	600
EV20D550K	550	745	310	10000	819	1001	1500	100	500
EV20D625K	625	825	342	10000	900	1100	1650	100	450
EV20D680K	680	895	383	10000	990	1210	1815	100	375
EV20D750K	750	990	408	10000	1080	1320	1980	100	320
EV20D1100K	1100	1465	625	10000	1620	1980	2970	100	220

**EV Standard Series – Electrical Characteristics**

22mm

Part Number	Maximum Continuous Rated Voltage		Rated Single Pulse Transient		Varistor Voltage @1mA DC		Maximum Clamping Voltage @Test Current 8/20µs		Typical Cpacitance @1KHZ 25°C
	AC RMS Volts	DC Volts	Energy	Peak	Min Volts	Max Volts	Volts	Amps	pF
			10/1000µs (joules)	8/20µs KA					
EV22D14K	14	18	28	6	20	25	43	35	37000
EV22D17K	17	22	33	6	24	31	53	35	30000
EV22D20K	20	26	42	6	30	37	65	35	24500
EV22D25K	25	31	49	6	35	44	77	35	21000
EV22D30K	30	38	60	10	42	52	93	35	17250
EV22D35K	35	45	72	10	50	63	110	35	14500
EV22D40K	40	56	85	10	61	75	135	35	9500
EV22D50K	50	65	98	18	74	90	135	175	8800
EV22D60K	60	85	122	18	90	110	165	175	7200
EV22D75K	75	100	146	*25	108	132	200	175	6000
EV22D95K	95	125	185	*25	135	165	250	175	4400
EV22D120K	120	150	218	*25	162	198	300	175	3650
EV22D130K	130	170	252	*25	185	225	340	175	3300
EV22D140K	140	180	280	*25	198	242	360	175	3000
EV22D150K	150	200	302	*25	222	270	395	175	2800
EV22D180K	180	225	340	*25	256	310	455	175	2450
EV22D195K	195	250	375	*25	270	330	500	175	2200
EV22D210K	210	275	410	*25	297	363	550	175	2050
EV22D230K	230	300	465	*25	324	396	595	175	1850
EV22D250K	250	320	520	*25	362	440	650	175	1700
EV22D275K	275	350	575	*25	387	473	710	175	1600
EV22D300K	300	385	630	*25	423	517	775	175	1450
EV22D320K	320	415	665	*25	459	561	845	175	1300
EV22D360K	360	460	720	*25	504	616	925	175	1200
EV22D390K	390	505	790	*25	558	682	1025	175	1100
EV22D420K	420	560	790	*25	612	748	1120	175	1000
EV22D460K	460	615	825	*25	675	825	1240	175	900
EV22D485K	485	640	860	*25	702	858	1290	175	850
EV22D510K	510	670	900	*22	738	902	1355	175	810
EV22D550K	550	745	950	*22	819	1001	1500	175	750
EV22D575K	575	780	950	*22	855	1045	1570	175	700
EV22D625K	625	825	1130	*22	900	1100	1650	175	660
EV22D680K	680	895	1140	*22	990	1210	1815	175	605
EV22D750K	750	980	1170	*22	1150	1320	1980	175	555
EV22D850K	850	1120	1170	20	1315	1540	2310	175	475
EV22D1000K	1000	1320	1300	20	1550	1760	2640	175	415

NOTE: \* = For wire leads suffix "KW" rating is 20KA.

**EV Standard Series – Electrical Characteristics**

**34mm**

Part Number	Maximum Continuous Rated Voltage		Rated Single Pulse Transient		Varistor Voltage @1mA DC		Maximum Clamping Voltage @Test Current 8/20µs		Typical Capacitance @1KHZ 25°C
			Energy	Peak					
	AC RMS Volts	DC Volts	10/1000µs (joules)	8/20µs KA	Min Volts	Max Volts	Volts	Amps	pF
EV34D30K	30	38	96	20	42	52	93	60	35000
EV34D35K	35	45	115	20	50	63	110	60	29500
EV34D40K	40	56	136	20	61	75	135	60	24200
EV34D50K	50	65	156	30	74	90	135	300	17950
EV34D60K	60	85	195	30	90	110	165	300	15000
EV34D75K	75	100	235	45	108	132	200	300	12200
EV34D95K	95	125	296	45	135	165	250	300	10000
EV34D120K	120	150	350	45	162	198	300	300	8250
EV34D130K	130	170	400	45	185	225	340	300	6750
EV34D140K	140	180	450	45	198	242	360	300	6400
EV34D150K	150	200	480	45	222	270	395	300	5650
EV34D180K	180	225	540	45	256	310	455	300	5100
EV34D195K	195	250	600	45	270	330	500	300	4510
EV34D210K	210	275	656	50	297	363	550	300	4150
EV34D230K	230	300	745	50	324	396	595	300	3750
EV34D250K	250	320	830	50	362	440	650	300	3500
EV34D275K	275	350	920	50	387	473	710	300	2950
EV34D300K	300	385	1000	50	423	517	775	300	2880
EV34D320K	320	415	1060	50	459	561	845	300	2650
EV34D360K	360	460	1150	50	504	616	925	300	2450
EV34D390K	390	505	1250	50	558	682	1025	300	2200
EV34D420K	420	560	1250	50	612	748	1120	300	2000
EV34D460K	460	615	1280	50	675	825	1240	300	1820
EV34D485K	485	640	1350	50	702	858	1290	300	1750
EV34D510K	510	670	1395	45	738	902	1355	300	1650
EV34D550K	550	745	1475	45	819	1001	1500	300	1500
EV34D575K	575	760	1485	45	855	1045	1570	300	1430
EV34D625K	625	825	1550	45	900	1100	1650	300	1350
EV34D680K	680	895	1700	45	990	1210	1815	300	1230
EV34D750K	750	980	1750	40	1150	1320	1980	300	1135
EV34D850K	850	1120	1750	40	1315	1540	2310	300	970
EV34D1000K	1000	1320	2000	40	1550	1760	2640	300	840



**EV High Energy (-J) Series  
Electrical Characteristics**

5mm -J

Part Number	Maximum Continuous Rated Voltage		Rated Single Pulse Transient		Varistor Voltage @1mA DC		Maximum Clamping Voltage @Test Current 8/20µs		Typical Capacitance @1KHZ 25°C
			Energy	Peak			Volts	Amps	
	AC RMS Volts	DC Volts	8/20µs (joules)	8/20µs Amps	Min Volts	Max Volts			pF
EV05D11K-J	11	14	0.6	250	16	20	40	1	1500
EV05D14K-J	14	18	0.7	250	20	24	48	1	1260
EV05D17K-J	17	22	0.9	250	24	30	60	1	1050
EV05D20K-J	20	26	1.1	250	30	36	73	1	850
EV05D25K-J	25	31	1.2	250	35	43	86	1	600
EV05D30K-J	30	38	1.5	250	42	52	104	1	500
EV05D35K-J	35	45	1.8	250	50	62	123	1	400
EV05D40K-J	40	56	2.2	250	61	75	150	1	360
EV05D50K-J	50	65	4.0	800	74	90	145	5	480
EV05D60K-J	60	85	4.1	800	90	110	175	5	420
EV05D75K-J	75	100	4.9	800	108	132	210	5	360
EV05D95K-J	95	125	6.5	800	135	165	260	5	280
EV05D120K-J	120	150	7.5	800	162	198	320	55	200
EV05D130K-J	130	170	8.5	800	185	225	355	5	160
EV05D140K-J	140	180	9.0	800	198	242	380	5	110
EV05D150K-J	150	200	10	800	216	264	415	5	105
EV05D180K-J	180	225	11	800	243	297	475	5	100
EV05D195K-J	195	250	12	800	270	330	520	5	95
EV05D210K-J	210	275	13	800	297	363	570	5	90
EV05D230K-J	230	300	16	800	324	396	620	5	85
EV05D250K-J	250	320	17	800	351	429	675	5	80
EV05D275K-J	275	350	20	800	387	473	745	5	70
EV05D300K-J	300	385	21	800	423	517	810	5	60
EV05D320K-J	320	415	23	800	459	561	845	5	55
EV05D360K-J	360	460	24	800	504	616	925	5	50

**EV High Energy (-J) Series  
Electrical Characteristics**

7mm -J

Part Number	Maximum Continuous Rated Voltage		Rated Single Pulse Transient		Varistor Voltage @1mA DC		Maximum Clamping Voltage @Test Current 8/20µs		Typical Capacitance @1KHZ 25°C
			Energy	Peak			Volts	Amps	
	AC RMS Volts	DC Volts	8/20µs (joules)	8/20µs Amps	Min Volts	Max Volts	Volts	Amps	pF
EV07D11K-J	11	14	2.0	500	16	20	36	2.5	2900
EV07D14K-J	14	18	2.4	500	20	24	43	2.5	2400
EV07D17K-J	17	22	3.0	500	24	30	53	2.5	1800
EV07D20K-J	20	26	4.0	500	30	36	65	2.5	1500
EV07D25K-J	25	31	4.0	500	35	43	77	2.5	1230
EV07D30K-J	30	38	5.0	500	42	52	93	2.5	950
EV07D35K-J	35	45	6.0	500	50	62	110	2.5	890
EV07D40K-J	40	56	7.0	500	61	75	135	2.5	850
EV07D50K-J	50	65	10	1750	74	90	135	10	930
EV07D60K-J	60	85	12	1750	90	110	165	10	860
EV07D75K-J	75	100	13	1750	108	132	200	10	670
EV07D95K-J	95	125	13	1750	135	165	250	10	490
EV07D120K-J	120	150	16	1750	162	198	300	10	330
EV07D130K-J	130	170	17	1750	185	225	340	10	240
EV07D140K-J	140	180	19	1750	198	242	360	10	190
EV07D150K-J	150	200	21	1750	216	264	395	10	165
EV07D180K-J	180	225	24	1750	243	297	455	10	150
EV07D195K-J	195	250	26	1750	270	330	500	10	140
EV07D210K-J	210	275	28	1750	297	363	550	10	130
EV07D230K-J	230	300	32	1750	324	396	595	10	125
EV07D250K-J	250	320	35	1750	351	429	650	10	115
EV07D275K-J	275	350	40	1750	387	473	710	10	110
EV07D300K-J	300	385	42	1750	423	517	775	10	100
EV07D320K-J	320	415	45	1750	459	561	845	10	90
EV07D360K-J	360	460	49	1750	504	616	925	10	85
EV07D390K-J	390	505	55	1750	558	682	1025	10	80
EV07D420K-J	420	560	60	1750	612	748	1120	10	75
EV07D460K-J	460	620	65	1750	675	825	1240	10	70
EV07D485K-J	485	640	65	1750	702	858	1290	10	70
EV07D510K-J	510	675	70	1750	738	902	1355	10	60

**EV High Energy (-J) Series  
Electrical Characteristics**

10mm -J

Part Number	Maximum Continuous Rated Voltage		Rated Single Pulse Transient		Varistor Voltage @1mA DC		Maximum Clamping Voltage @Test Current 8/20µs		Typical Capacitance @1KHZ 25°C
			Energy	Peak			Volts	Amps	
	AC RMS Volts	DC Volts	8/20µs (joules)	8/20µs Amps	Min Volts	Max Volts			pF
EV10D11K-J	11	14	3.0	1000	16	20	36	5	6000
EV10D14K-J	14	18	5.0	1000	20	24	43	5	5000
EV10D17K-J	17	22	6.0	1000	24	30	53	5	4000
EV10D20K-J	20	26	7.0	1000	30	36	65	5	3500
EV10D25K-J	25	31	9.0	1000	35	43	77	5	3100
EV10D30K-J	30	38	11	1000	42	52	93	5	2800
EV10D35K-J	35	45	13	1000	50	62	110	5	2400
EV10D40K-J	40	56	15	1000	61	75	135	5	2200
EV10D50K-J	50	65	17	3500	74	90	135	25	2100
EV10D60K-J	60	85	18	3500	90	110	165	25	1700
EV10D75K-J	75	100	21	3500	108	132	200	25	1500
EV10D95K-J	95	125	25	3500	135	165	250	25	1300
EV10D120K-J	120	150	30	3500	162	198	300	25	470
EV10D130K-J	130	170	35	3500	185	225	340	25	430
EV10D140K-J	140	180	39	3500	198	242	360	25	390
EV10D150K-J	150	200	42	3500	216	264	395	25	360
EV10D180K-J	180	225	49	3500	243	297	455	25	330
EV10D195K-J	195	250	54	3500	270	330	500	25	290
EV10D210K-J	210	275	58	3500	297	363	550	25	280
EV10D230K-J	230	300	65	3500	324	396	595	25	260
EV10D250K-J	250	320	70	3500	351	429	650	25	240
EV10D275K-J	275	350	80	3500	387	473	710	25	220
EV10D300K-J	300	385	85	3500	423	517	775	25	200
EV10D320K-J	320	415	90	3500	459	561	845	25	190
EV10D360K-J	360	460	92	3500	504	616	825	25	180
EV10D390K-J	390	505	95	3500	558	682	1025	25	160
EV10D420K-J	420	560	98	3500	612	748	1120	25	140
EV10D460K-J	460	615	100	3500	675	825	1240	25	130
EV10D485K-J	485	640	105	3500	702	858	1290	25	130
EV10D510K-J	510	670	110	3500	738	902	1355	25	130
EV10D550K-J	550	745	130	3500	819	1001	1500	25	120
EV10D625K-J	625	825	140	3500	900	1100	1650	25	100
EV10D680K-J	680	895	155	3500	990	1210	1815	25	90

**EV High Energy (-J) Series  
Electrical Characteristics**

**14mm -J**

Part Number	Maximum Continuous Rated Voltage		Rated Single Pulse Transient		Varistor Voltage @1mA DC		Maximum Clamping Voltage @Test Current 8/20µs		Typical Capacitance @1KHZ 25°C
			Energy	Peak					
	AC RMS Volts	DC Volts	8/20µs (joules)	8/20µs Amps	Min Volts	Max Volts	Volts	Amps	pF
EV14D11K-J	11	14	7.0	2000	16	20	36	10	15000
EV14D14K-J	14	18	8.0	2000	20	24	43	10	12000
EV14D17K-J	17	22	10	2000	24	30	53	10	8500
EV14D20K-J	20	26	12	2000	30	36	65	10	7200
EV14D25K-J	25	31	13	2000	35	43	77	10	6300
EV14D30K-J	30	38	17	2000	42	52	93	10	5500
EV14D35K-J	35	45	20	2000	50	62	110	10	4800
EV14D40K-J	40	56	24	2000	61	75	135	10	4000
EV14D50K-J	50	65	27	6000	74	90	135	50	3900
EV14D60K-J	60	85	33	6000	90	110	165	50	3400
EV14D75K-J	75	100	40	6000	108	132	200	50	3100
EV14D95K-J	95	125	53	6000	135	165	250	50	3000
EV14D120K-J	120	150	60	6000	162	198	300	50	1030
EV14D130K-J	130	170	70	6000	185	225	340	50	970
EV14D140K-J	140	180	78	6000	198	242	360	50	840
EV14D150K-J	150	200	84	6000	216	264	395	50	710
EV14D180K-J	180	225	99	6000	243	297	455	50	650
EV14D195K-J	195	250	108	6000	270	330	500	50	600
EV14D210K-J	210	275	115	6000	297	363	550	50	550
EV14D230K-J	230	300	130	6000	324	396	595	50	530
EV14D250K-J	250	320	140	6000	351	429	650	50	500
EV14D275K-J	275	350	155	6000	387	473	710	50	480
EV14D300K-J	300	385	175	6000	423	517	775	50	440
EV14D320K-J	320	415	180	6000	459	561	845	50	390
EV14D350K-J	350	460	185	6000	504	616	825	50	360
EV14D390K-J	390	505	190	6000	558	682	1025	50	320
EV14D420K-J	420	560	200	6000	612	748	1120	50	300
EV14D460K-J	460	615	210	6000	675	825	1240	50	280
EV14D485K-J	485	640	220	6000	702	858	1290	50	250
EV14D510K-J	510	670	235	6000	738	902	1355	50	230
EV14D550K-J	550	745	255	6000	819	1001	1500	50	200
EV14D625K-J	625	825	280	6000	900	1100	1650	50	180
EV14D680K-J	680	895	310	6000	990	1210	1815	50	150

**EV High Energy (-J) Series  
Electrical Characteristics (5, 7, 10, 14, and 20mm)**

**20mm -J**

Part Number	Maximum Continuous Rated Voltage		Rated Single Pulse Transient		Varistor Voltage @1mA DC		Maximum Clamping Voltage @Test Current 8/20µs		Typical Capacitance @1KHZ 25°C
			Energy	Peak			Volts	Amps	
	AC RMS Volts	DC Volts	8/20µs (joules)	8/20µs Amps	Min Volts	Max Volts			pF
EV20D11K-J	11	14	13	3000	16	20	36	20	27000
EV20D14K-J	14	18	16	3000	20	24	43	20	20000
EV20D17K-J	17	22	19	3000	24	30	53	20	15000
EV20D20K-J	20	26	24	3000	30	36	65	20	12200
EV20D25K-J	25	31	28	3000	35	43	77	20	10000
EV20D30K-J	30	38	34	3000	42	52	93	20	9350
EV20D35K-J	35	45	41	3000	50	62	110	20	8000
EV20D40K-J	40	56	49	3000	61	75	135	20	6800
EV20D50K-J	50	65	56	10000	74	90	135	100	5800
EV20D60K-J	60	85	70	10000	90	110	165	100	3800
EV20D75K-J	75	100	85	10000	108	132	200	100	3000
EV20D95K-J	95	125	106	10000	135	165	250	100	2600
EV20D120K-J	120	150	130	12000	162	198	300	100	2400
EV20D130K-J	130	170	140	12000	185	225	340	100	1800
EV20D140K-J	140	180	155	12000	198	242	360	100	1500
EV20D150K-J	150	200	168	12000	216	264	395	100	1400
EV20D180K-J	180	225	190	12000	243	297	455	100	1350
EV20D195K-J	195	250	210	12000	270	330	500	100	1300
EV20D210K-J	210	275	228	12000	297	363	550	100	1250
EV20D230K-J	230	300	255	12000	324	396	595	100	1180
EV20D250K-J	250	320	275	12000	351	429	650	100	1100
EV20D275K-J	275	350	305	12000	387	473	710	100	1050
EV20D300K-J	300	385	350	12000	423	517	775	100	1000
EV20D320K-J	320	415	360	12000	459	561	845	100	970
EV20D360K-J	360	460	380	12000	504	616	825	100	950
EV20D390K-J	390	505	390	12000	558	682	1025	100	900
EV20D420K-J	420	560	400	12000	612	748	1120	100	850
EV20D460K-J	460	615	420	12000	675	825	1240	100	750
EV20D485K-J	485	640	440	12000	702	858	1290	100	700
EV20D510K-J	510	670	460	12000	738	902	1355	100	600
EV20D550K-J	550	745	510	12000	819	1001	1500	100	500
EV20D625K-J	625	825	565	12000	900	1100	1650	100	450
EV20D680K-J	680	895	620	12000	990	1210	1815	100	375

**EV Ultra High Energy (-H) Series  
Electrical Characteristics**

**14mm -H**

Part Number	Maximum Continuous Rated Voltage		Rated Single Pulse Transient		Varistor Voltage @1mA DC		Maximum Clamping Voltage @Test Current 8/20µs		Typical Capacitance @1KHZ 25°C
			Energy	Peak			Volts	Amps	
	AC RMS Volts	DC Volts	8/20µs (joules)	8/20µs Amps	Min Volts	Max Volts	Volts	Amps	pF
EV14D120K-H	120	150	72	7500	162	198	300	50	1030
EV14D130K-H	130	170	84	7500	185	225	340	50	970
EV14D140K-H	140	180	94	7500	198	242	360	50	840
EV14D150K-H	150	200	100	7500	216	264	395	50	710
EV14D180K-H	180	225	120	7500	243	297	455	50	650
EV14D195K-H	195	250	130	7500	270	330	500	50	600
EV14D210K-H	210	275	140	7500	297	363	550	50	550
EV14D230K-H	230	300	155	7500	324	396	595	50	530
EV14D250K-H	250	320	190	7500	351	429	650	50	500
EV14D275K-H	275	350	210	7500	387	473	710	50	480
EV14D300K-H	300	385	215	7500	423	517	775	50	440
EV14D320K-H	320	415	220	7500	459	561	845	50	390
EV14D350K-H	350	460	230	7500	504	616	825	50	360
EV14D390K-H	390	505	240	7500	558	682	1025	50	320
EV14D420K-H	420	560	250	7500	612	748	1120	50	300
EV14D460K-H	460	615	250	7500	675	825	1240	50	280
EV14D485K-H	485	640	265	7500	702	858	1290	50	250
EV14D510K-H	510	670	280	7500	738	902	1355	50	230
EV14D550K-H	550	745	310	7500	819	1001	1500	50	200
EV14D625K-H	625	825	340	7500	900	1100	1650	50	180
EV14D680K-H	680	895	370	7500	990	1210	1815	50	150

**EV Ultra High Energy (-H) Series  
Electrical Characteristics**

20mm -H

Part Number	Maximum Continuous Rated Voltage		Rated Single Pulse Transient		Varistor Voltage @1mA DC		Maximum Clamping Voltage @Test Current 8/20µs		Typical Capacitance @1KHZ 25°C
			Energy	Peak			Volts	Amps	
	AC RMS Volts	DC Volts	8/20µs (joules)	8/20µs Amps	Min Volts	Max Volts			pF
EV20D120K-H	120	150	156	13000	162	198	300	100	2400
EV20D130K-H	130	170	175	13000	185	225	340	100	1800
EV20D140K-H	140	180	186	13000	198	242	360	100	1500
EV20D150K-H	150	200	200	13000	216	264	395	100	1400
EV20D180K-H	180	225	230	13000	243	297	455	100	1350
EV20D195K-H	195	250	250	13000	270	330	500	100	1300
EV20D210K-H	210	275	275	13000	297	363	550	100	1250
EV20D230K-H	230	300	310	13000	324	396	595	100	1180
EV20D250K-H	250	320	330	13000	351	429	650	100	1100
EV20D275K-H	275	350	360	13000	387	473	710	100	1050
EV20D300K-H	300	385	420	13000	423	517	775	100	1000
EV20D320K-H	320	415	432	13000	459	561	845	100	970
EV20D360K-H	360	460	455	13000	504	616	825	100	950
EV20D390K-H	390	505	470	13000	558	682	1025	100	900
EV20D420K-H	420	560	480	13000	612	748	1120	100	850
EV20D460K-H	460	615	505	13000	675	825	1240	100	750
EV20D485K-H	485	640	530	13000	702	858	1290	100	700
EV20D510K-H	510	670	550	13000	738	902	1355	100	600
EV20D550K-H	550	745	612	13000	819	1001	1500	100	500
EV20D625K-H	625	825	680	13000	900	1100	1650	100	450
EV20D680K-H	680	895	745	13000	990	1210	1815	100	375

**EV Ultra High Energy (-H) Series  
Electrical Characteristics**

**34mm -H**

Part Number	Maximum Continuous Rated Voltage		Rated Single Pulse Transient		Varistor Voltage @1mA DC		Maximum Clamping Voltage @Test Current 8/20µs		Typical Capacitance @1KHZ 25°C
			Energy	Peak					
	AC RMS Volts	DC Volts	10/1000µs (joules)	8/20µs KA	Min Volts	Max Volts	Volts	Amps	pF
EV34D60K-H	60	85	200	45	90	110	165	300	15000
EV34D75K-H	75	100	250	45	108	132	200	300	12200
EV34D95K-H	95	125	300	50	135	165	250	300	10000
EV34D120K-H	120	150	400	50	162	198	300	300	8250
EV34D130K-H	130	170	450	50	185	225	340	300	6750
EV34D140K-H	140	180	500	50	198	242	360	300	6400
EV34D150K-H	150	200	550	50	222	270	395	300	5650
EV34D180K-H	180	225	630	50	256	310	455	300	5100
EV34D195K-H	195	250	700	50	270	330	500	300	4510
EV34D210K-H	210	275	800	60	297	363	550	300	4150
EV34D230K-H	230	300	850	60	324	396	595	300	3750
EV34D250K-H	250	320	930	60	362	440	650	300	3500
EV34D275K-H	275	350	1050	60	387	473	710	300	2950
EV34D300K-H	300	385	1150	60	423	517	775	300	2880
EV34D320K-H	320	415	1200	60	459	561	845	300	2650
EV34D360K-H	360	460	1300	60	504	616	925	300	2450
EV34D390K-H	390	505	1400	60	558	682	1025	300	2200
EV34D420K-H	420	560	1400	60	612	748	1120	300	2000
EV34D460K-H	460	615	1500	60	675	825	1240	300	1820
EV34D485K-H	485	640	1550	60	702	858	1290	300	1750
EV34D510K-H	510	670	1650	60	738	902	1355	300	1650
EV34D550K-H	550	745	1750	60	819	1001	1500	300	1500



## Peak Pulse and Derating Curve

### Peak Current Per Pulse Versus Pulse Duration

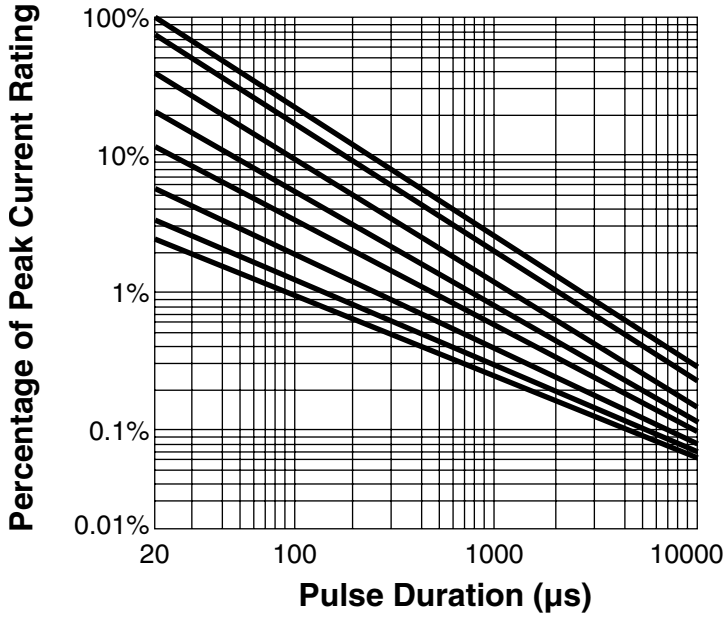

- 1 Repetition - (Top line on graph)
- 2 Repetitions
- 10 Repetitions
- 10<sup>2</sup> Repetitions
- 10<sup>3</sup> Repetitions
- 10<sup>4</sup> Repetitions
- 10<sup>5</sup> Repetitions
- 10<sup>6</sup> Repetitions - (Bottom line on graph)

### Soldering Profile

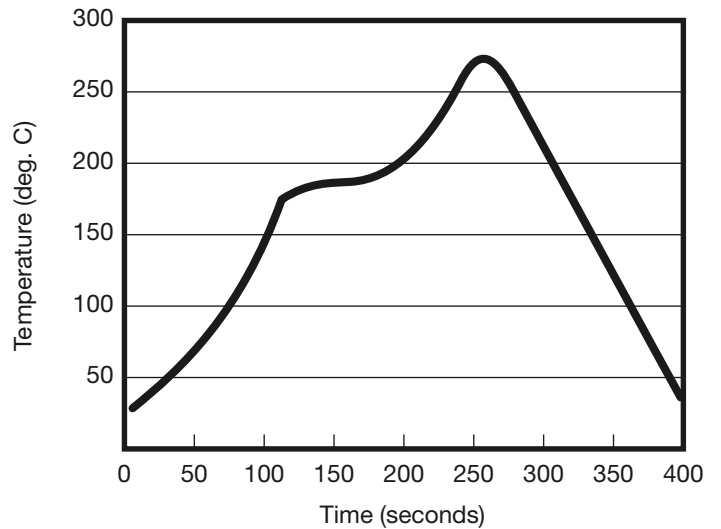

### Temperature Derating Curve Power and Energy Rating vs. Temperature

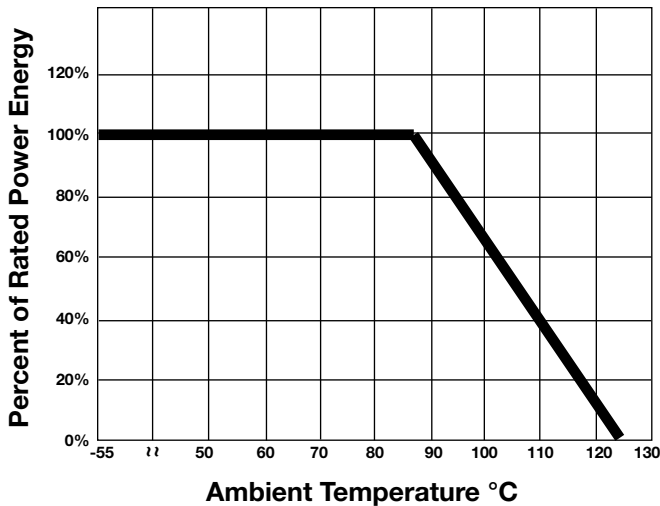

### Power Dissipation Ratings

Disk Size	Pm-watts
5mm (< 50 VAC)	0.01
5mm (≥ 50 VAC)	0.20
7mm (< 50 VAC)	0.02
7mm (≥ 50 VAC)	0.25
10mm (< 50 VAC)	0.05
10mm (≥ 50 VAC)	0.40
14mm (< 50 VAC)	0.10
14mm (≥ 50 VAC)	0.60
20mm (< 50 VAC)	0.20
20mm (≥ 50 VAC)	1.00
22mm (< 50 VAC)	0.25
22mm (≥ 50 VAC)	1.20
34mm (< 50 VAC)	0.30
34mm (≥ 50 VAC)	1.40

## V-I Characteristics

### 5mm Disk Size (VAC)

- 360 - (Top line on graph)
- 300
- 275
- 250
- 230
- 180
- 150
- 140
- 130
- 95
- 75
- 60
- 50 - (Bottom line on graph)

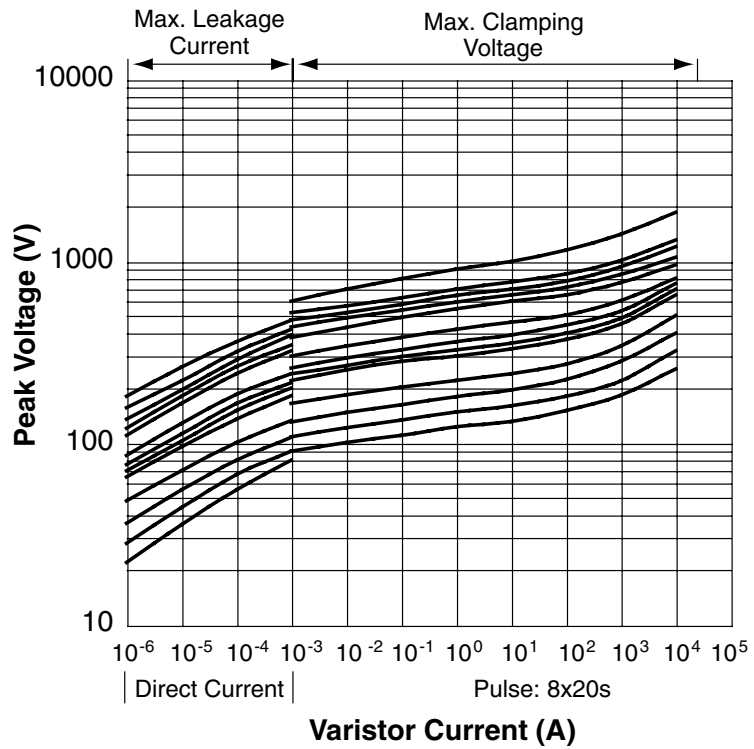

### 7mm Disk Size (VAC)

- 420 - (Top line on graph)
- 390
- 360
- 320
- 300
- 250
- 210
- 180
- 150
- 130
- 120
- 95
- 75
- 60
- 50 - (Bottom line on graph)

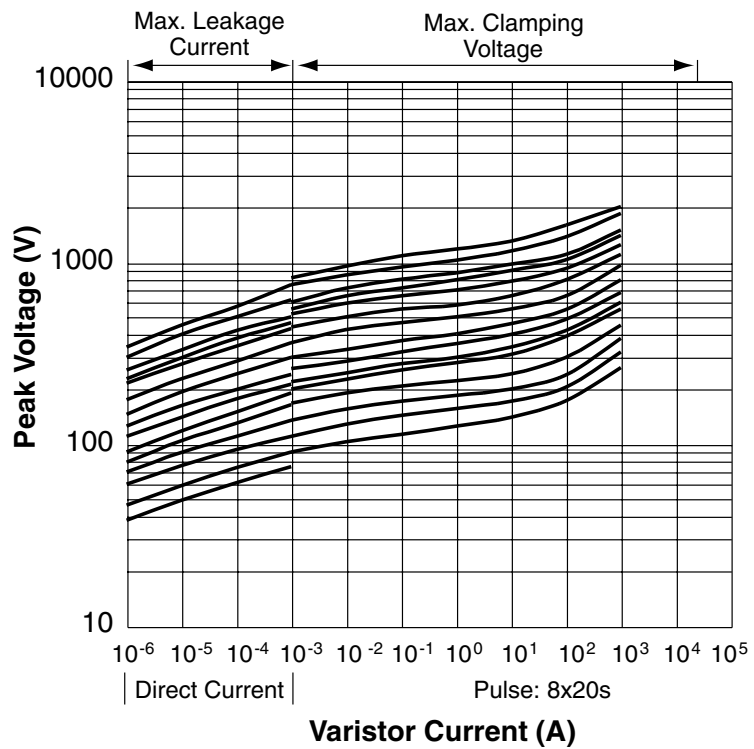

At idle power, current levels shown to the left of the diskontinuity illustrate typically the high end leakage current. However, if lower leakage current levels are desired, they may be guaranteed. In the clamping voltage region to the right of the diskontinuity, maximum clamping voltage is plotted.

**V-I Characteristics (continued)**

**10mm Disk Size (VAC)**

- 680 - (Top line on graph)
- 625
- 550
- 460
- 420
- 390
- 300
- 250
- 180
- 150
- 140
- 130
- 95
- 75
- 60
- 50 - (Bottom line on graph)

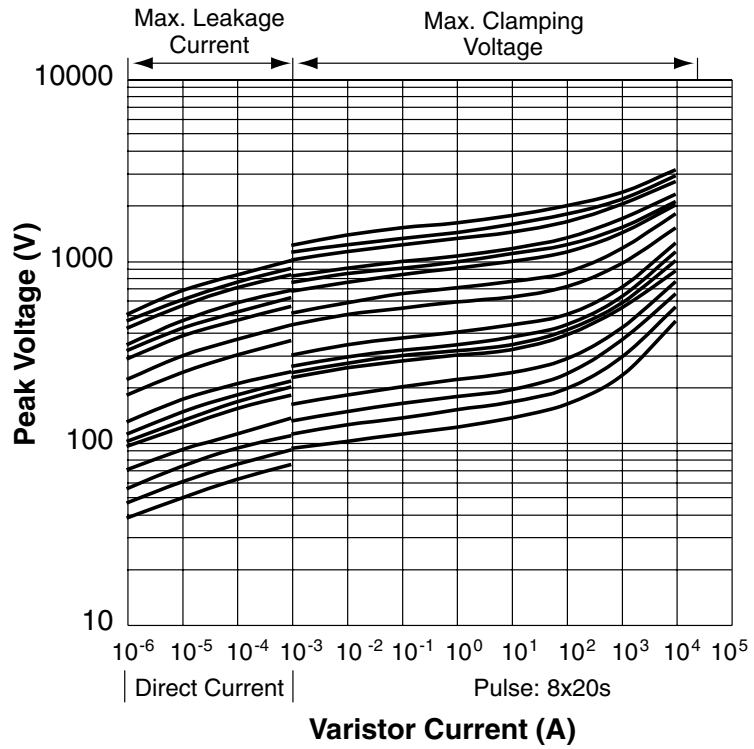

**14mm Disk Size (VAC)**

- 680 - (Top line on graph)
- 550
- 510
- 420
- 390
- 300
- 275
- 250
- 230
- 180
- 150
- 130
- 95
- 75
- 60
- 50 - (Bottom line on graph)

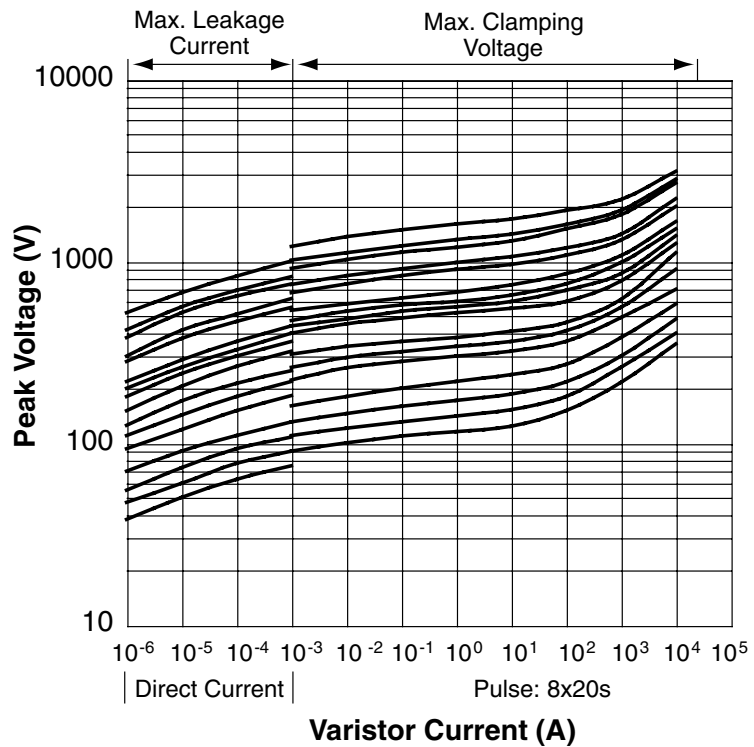

At idle power, current levels shown to the left of the diskontinuity illustrate typically the high end leakage current. However, if lower leakage current levels are desired, they may be guaranteed. In the clamping voltage region to the right of the diskontinuity, maximum clamping voltage is plotted.

**V-I Characteristics (continued)**

**20mm Disk Size (VAC)**

- 680 - (Top line on graph)
- 550
- 510
- 420
- 300
- 275
- 250
- 180
- 150
- 140
- 130
- 95
- 75
- 60
- 50 - (Bottom line on graph)

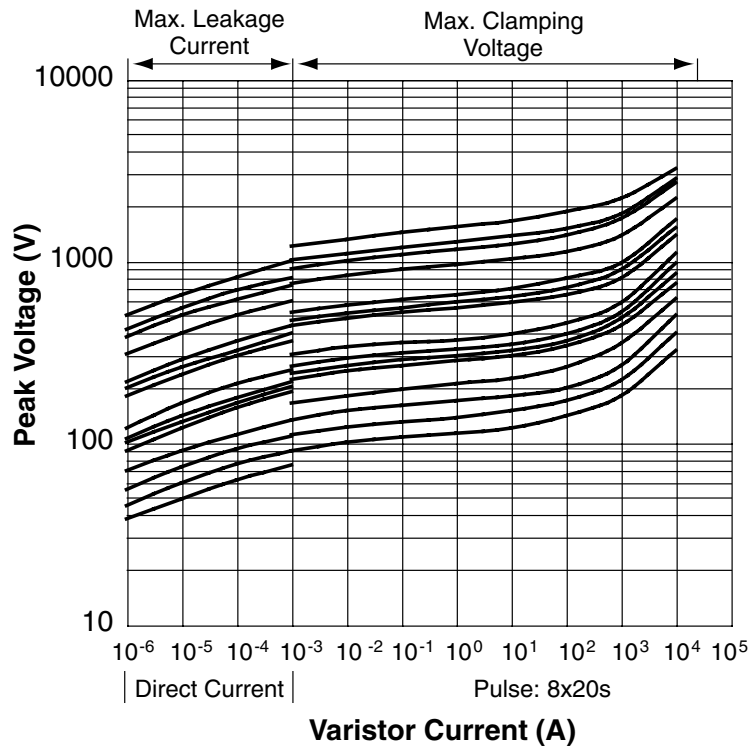

At idle power, current levels shown to the left of the diskontinuity illustrate typically the high end leakage current. However, if lower leakage current levels are desired, they may be guaranteed. In the clamping voltage region to the right of the diskontinuity, maximum clamping voltage is plotted.

**22mm Disk Size (VAC)**

- 575 - (Top line on graph)
- 550
- 510
- 460
- 420
- 390
- 320
- 300
- 275
- 250
- 230
- 180
- 150
- 130 - (Bottom line on graph)

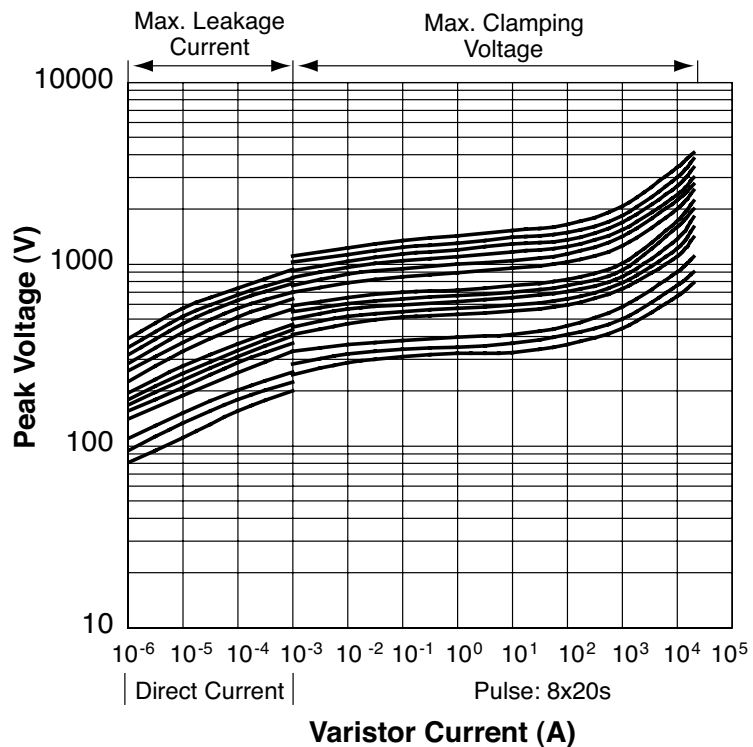

At idle power, current levels shown to the left of the diskontinuity illustrate typically the high end leakage current. However, if lower leakage current levels are desired, they may be guaranteed. In the clamping voltage region to the right of the diskontinuity, maximum clamping voltage is plotted.

**V-I Characteristics (continued)**

**34mm Disk Size (VAC)**

- 575 - (Top line on graph)
- 550
- 510
- 460
- 420
- 390
- 320
- 300
- 275
- 250
- 230
- 180
- 150
- 130 - (Bottom line on graph)

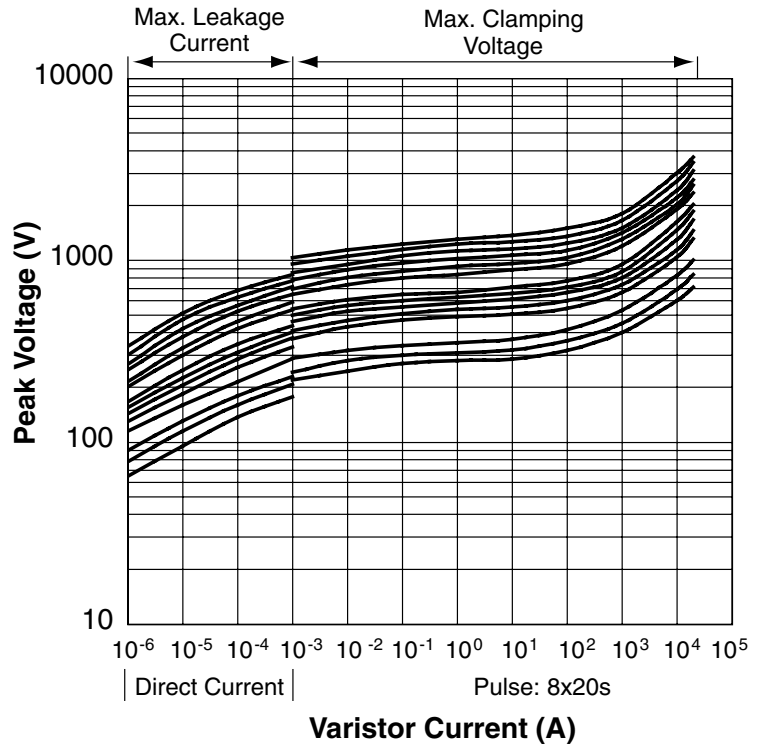

## Standard Bulk Packaging

Disk Size mm	AC RMS Voltage	Quantity pieces/bag	Quantity pieces/box	Quantity pieces/carton
5	ALL	500	2000	20000
7	ALL	500	2000	20000
10	11 - 300	500	1000	10000
	≥ 320	500	1000	10000
14	11 - 230	500	1000	10000
	≥ 250	250	500	5000
20	11 - 390	250	500	5000
	≥ 420	250	250	2500
22	20 - 250	60 (BOX)	---	480
	≥ 250	32 (BOX)	---	256
34	20 - 230	60 (BOX)	---	480
	250 - 680	32 (BOX)	---	256
	750 - 1000	16 (BOX)	---	192

**NOTE:** Applies to EV standard, -“J”, -“H” suffix and “Pin Type” series parts.

## 5mm / 7mm Taping Specifications

Item	Symbol	5mm Disk Size		7mm Disk Size	
		T11, T1	T17, T3, T1D, T14, T1W, T32	T11, T1	T17, T3, T1D, T14, T1W, T32
Body Diameter	D	7 max	7 max	9.5 max	9.5 max
Lead Wire Diameter	d	0.6 ± 0.02	0.6 ± 0.02	0.6 ± 0.02	0.6 ± 0.02
Pitch of Component	P	12.7 ± 1	12.7 ± 1	12.7 ± 1	12.7 ± 1
Feed Hole Pitch	P0	12.7 ± 0.3	12.7 ± 0.3	12.7 ± 0.3	12.7 ± 0.3
Feed Hole Center to Lead	P1	3.85 ± 0.7	3.85 ± 0.7	3.85 ± 0.7	3.85 ± 0.7
Lead to Lead Distance (Center to Center)	F	5 ± 0.8	5 ± 0.8	5 ± 0.8	5 ± 0.8
Component Alignment	△h	2.0 max	2.0 max	2.0 max	2.0 max
Basepaper Tape Width	W	18 +1/-0.5	18 +1/-0.5	18 +1/-0.5	18 +1/-0.5
Adhesive Tape Width	W0	10 min	10 min	10 min	10 min
Hole Position	W1	9 ± 0.5	9 ± 0.5	9 ± 0.5	9 ± 0.5
Adhesive Tape Border	W2	3 max	3 max	3 max	3 max
Component Height	H1	30 max	30 max	32 max	32 max
Lead-Wire Clinch Height	H0	—	16 ± 0.5	—	16 ± 0.5
Lead-Wire Protrusion	Lx	1.0 max	1.0 max	1.0 max	1.0 max
Feed Hole Diameter	D0	4 ± 0.2	4 ± 0.2	4 ± 0.2	4 ± 0.2
Total Tape Thickness	t	»0.7 max	»0.7 max	»0.7 max	»0.7 max
Length of Clipped Lead	L	11 max	11 max	11 max	11 max
Component Height from Seating Plane	A	—	13 max	—	15 max
Hole Center to Component Center	P2	6.35 ± .7	6.35 ± .7	6.35 ± .7	6.35 ± .7

All dimensions are in Millimeters.

Note: Basepaper Thickness = 0.375mm ± 0.1mm (Ammo Box), 0.53mm ± 0.1mm (Reel)

Adhesive Tape Thickness = 0.16mm ± 0.03mm

Largest voltage which can be taped is 420VAC. For 320VAC and larger, only T1W or T32 is available

**5mm / 7mm Taping Specifications (continued)**

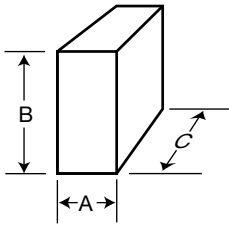

**Ammo Box**

5mm and 7mm Disk Size, (T11, T17, T1D, T1W)

A = 50 max, B = 300 max, C = 340 max

- 2,000 pieces (5 $\emptyset$ )
- < 250VAC = 1,500 pieces (7 $\emptyset$ )
- $\geq$  250VAC = 1,000 pieces (7 $\emptyset$ )

All dimensions are in Millimeters.

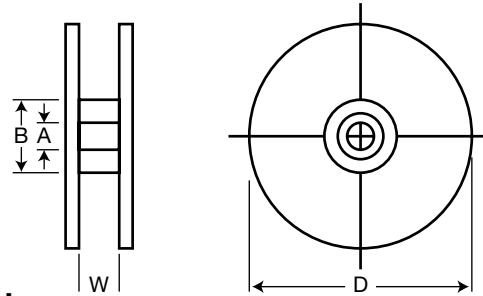

**Reel**

5mm and 7mm Disk Size, (T1, T3, T14, T32)

- W = Approximately 50, D = 350 $\emptyset$ max,
- A = Approximately 30 $\emptyset$ , B = Approximately 95 $\emptyset$
- 2,000 pieces (5 $\emptyset$ )
- < 250VAC = 1,500 pieces (7 $\emptyset$ )
- $\geq$  250VAC = 1,000 pieces (7 $\emptyset$ )

**Straight Lead  
T11 (Ammo Box) and T1 (Reel)**

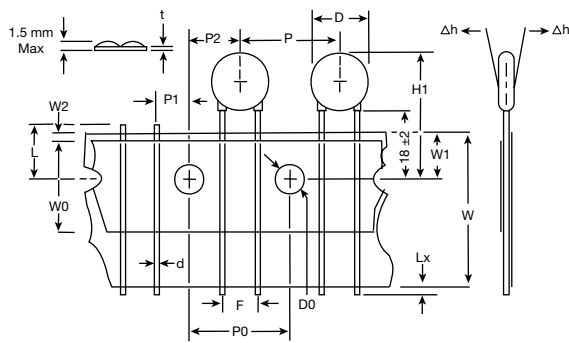

**Outward Crimp  
T17 (Ammo Box) and T3 (Reel)**

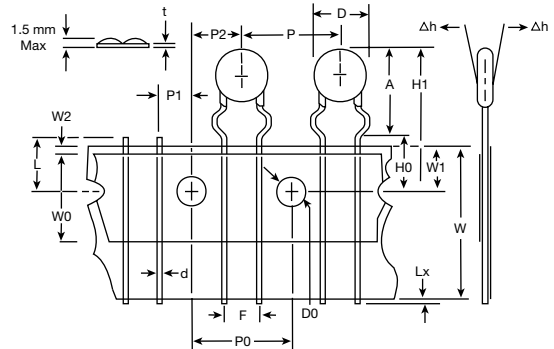

**Inward Crimp  
T1D (Ammo Box) and T14 (Reel)**

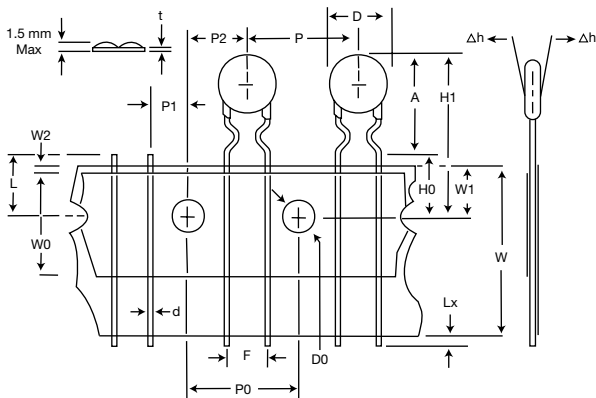

**In-Line Crimp  
T1W (Ammo Box) and T32 (Reel)**

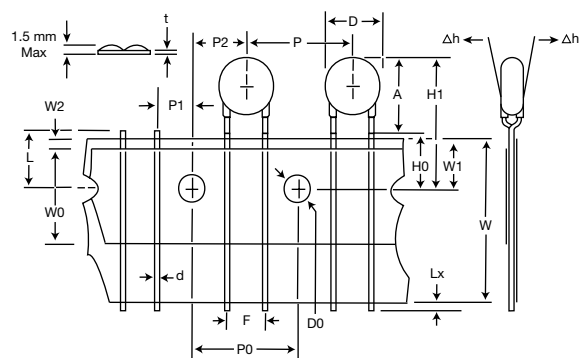

Based on EIA-468-B Specifications.



## 10mm Taping Specifications

Item	Symbol	Straight Leads		Outward Crimp		Inline Crimp		Inward Crimp	
		T36, T19	T7, T18	T1U, T1N	T10, T26	T43, T4	T15, T38	T8, T16	T6, T12
Body Diameter	D	12.5 max	12.5 max	12.5 max	12.5 max	12.5 max	12.5 max	12.5 max	12.5 max
Lead Wire Diameter	d	0.8 ± 0.06	0.8 ± 0.06	0.8 ± 0.06	0.8 ± 0.06	0.8 ± 0.06	0.8 ± 0.06	0.8 ± 0.06	0.8 ± 0.06
Pitch of Component	P	25.4 ± 1	25.4 ± 1	25.4 ± 1	25.4 ± 1	25.4 ± 1	25.4 ± 1	25.4 ± 1	25.4 ± 1
Feed Hole Pitch	P0	12.7 ± 0.3	12.7 ± 0.3	12.7 ± 0.3	12.7 ± 0.3	12.7 ± 0.3	12.7 ± 0.3	12.7 ± 0.3	12.7 ± 0.3
Feed Hole Center to Lead	P1		3.85 ± 0.7		3.85 ± 0.7		3.85 ± 0.7		3.85 ± 0.7
Lead to Lead Distance (Center to Center)	F	7.5 ± 0.8	5.0 ± 0.8	7.5 ± 0.8	5.0 ± 0.8	7.5 ± 0.8	5.0 ± 0.8	7.5 ± 0.8	5.0 ± 0.8
Component Alignment	Δh	2.0 max	2.0 max	2.0 max	2.0 max	2.0 max	2.0 max	2.0 max	2.0 max
Basepaper Tape Width	W	18 +1/-0.5	18 +1/-0.5	18 +1/-0.5	18 +1/-0.5	18 +1/-0.5	18 +1/-0.5	18 +1/-0.5	18 +1/-0.5
Adhesive Tape Width	W0	10 min	10 min	10 min	10 min	10 min	10 min	10 min	10 min
Hole Position	W1	9 ± 0.5	9 ± 0.5	9 ± 0.5	9 ± 0.5	9 ± 0.5	9 ± 0.5	9 ± 0.5	9 ± 0.5
Adhesive Tape Border	W2	3 max	3 max	3 max	3 max	3 max	3 max	3 max	3 max
Component Height	H1	33 max	33 max	38.5 max	38.5 max	35.5 max	38.5 max	38.5 max	38.5 max
Lead-Wire Protrusion	Lx	1.0 max	1.0 max	1.0 max	1.0 max	1.0 max	1.0 max	1.0 max	1.0 max
Feed Hole Diameter	D0	4 ± 0.2	4 ± 0.2	4 ± 0.2	4 ± 0.2	4 ± 0.2	4 ± 0.2	4 ± 0.2	4 ± 0.2
Total Tape Thickness	t	»0.7 max	»0.7 max	»0.7 max	»0.7 max	»0.7 max	»0.7 max	»0.7 max	»0.7 max
Length of Clipped Lead	L	11 max	11 max	11 max	11 max	11 max	11 max	11 max	11 max
Component Height from Seating Plane	A	—	—	19.5 max	19.5 max	19.5 max	19.5 max	19.5 max	19.5 max
Hole Center to Component Center	P2		6.35 ± 0.7		6.35 ± 0.7		6.35 ± 0.7		6.35 ± 0.7

All dimensions are in Millimeters.

Note: Basepaper Thickness = 0.375mm ± 0.1mm (Ammo Box), 0.53mm ± 0.1mm (Reel)

Adhesive Tape Thickness = 0.16mm ± 0.03mm

Largest voltage which can be taped is 460VAC. For 320VAC and larger, only T15, T43, T38 or T4 is available

## 10mm Taping Specifications (continued)

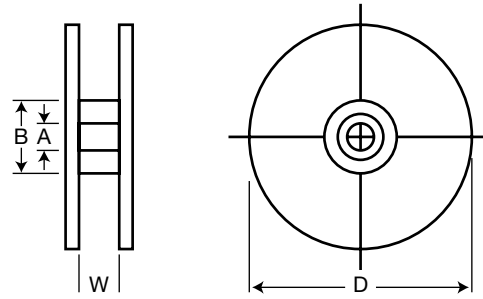
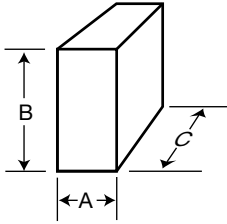

### Ammo Box

Ammo Box Taping Codes  
(T7, T36, T15, T43, T1U, T10, T8, T6)

A = 65 max  
B = 250 max  
C = 340 max

< 300VAC = 500 to 1,000 pieces  
≥ 300VAC = 300 pieces

All dimensions are in Millimeters.

### Reel

Reel Taping Codes  
(T19, T18, T4, T38, T26, T1N, T16, T12)

W = Approximately 50  
D = 350ømax  
A = Approximately 30ø  
B = Approximately 95ø

< 300VAC = 500 to 1,000 pieces  
≥ 300VAC = 300 pieces

10mm Taping Specifications (continued)

**Straight Lead**  
**T7 (Ammo Box) and T18 (Reel)**  
**(5mm Lead Spacing)**

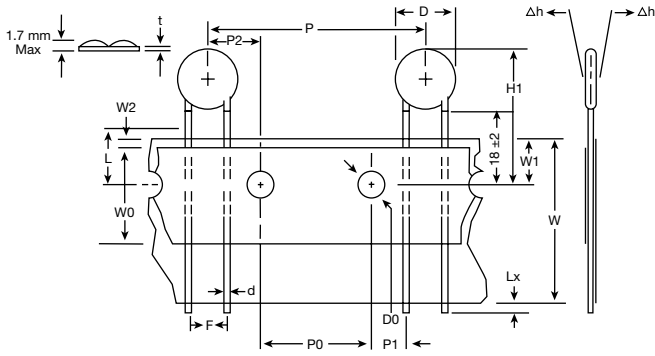

**Straight Lead**  
**T36 (Ammo Box) and T19 (Reel)**  
**(7.5mm Lead Spacing)**

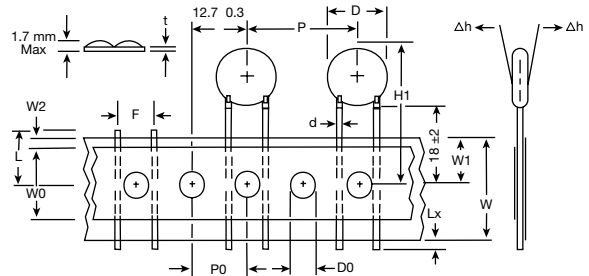

**In-Line Crimp**  
**T15 (Ammo Box) and T38 (Reel)**  
**(5mm Lead Spacing)**

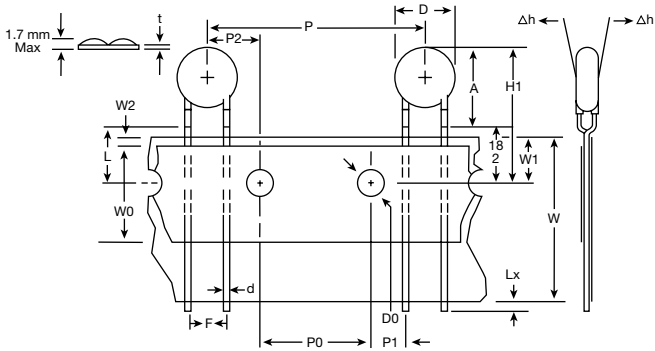

**In-Line Crimp**  
**T43 (Ammo Box) and T4 (Reel)**  
**(7.5mm Lead Spacing)**

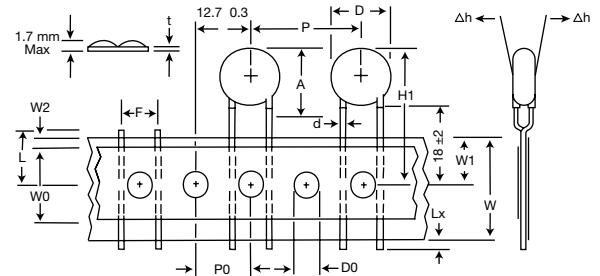

Based on EIA-468-B Specifications.

10mm Taping Specifications (continued)

**Outward Crimp**  
**T10 ( Ammo Box) and T26 (Reel)**  
**(5mm Lead Spacing)**

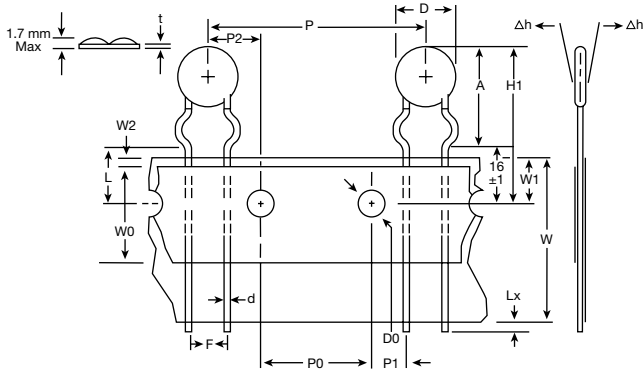

**Outward Crimp**  
**T1U ( Ammo Box) and T1N (Reel)**  
**(7.5mm Lead Spacing)**

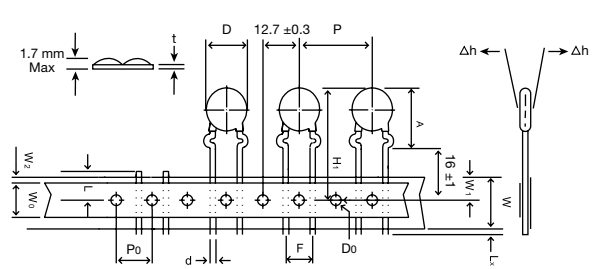

**Inward Crimp**  
**T6 ( Ammo Box) and T12 (Reel)**  
**(5mm Lead Spacing)**

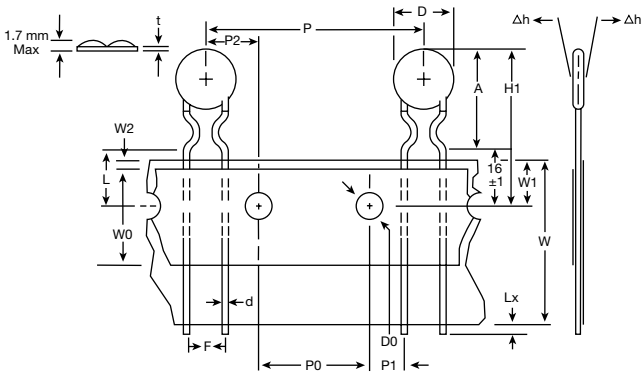

**Inward Crimp**  
**T8 ( Ammo Box) and T16 (Reel)**  
**(7.5mm Lead Spacing)**

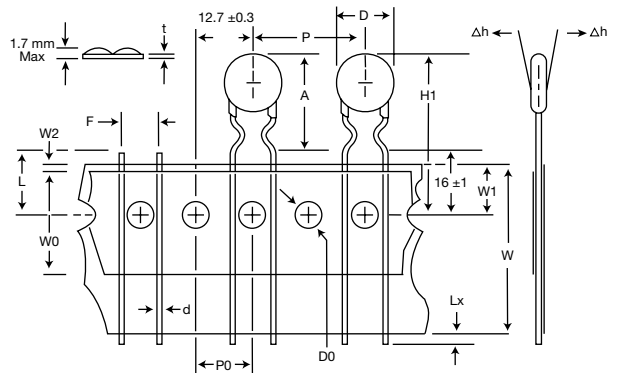

Based on EIA-468-B Specifications.

## 14mm Taping Specifications

Item	Symbol	Straight Leads		Outward Crimp		Inline Crimp		Inward Crimp	
		T36, T19	T7, T18	T1U, T1N	T10, T26	T43, T4	T15, T38	T8, T16	T6, T12
Body Diameter	D	16.5 max	16.5 max	16.5 max	16.5 max	16.5 max	16.5 max	16.5 max	16.5 max
Lead Wire Diameter	d	0.8 ± 0.06	0.8 ± 0.06	0.8 ± 0.06	0.8 ± 0.06	0.8 ± 0.06	0.8 ± 0.06	0.8 ± 0.06	0.8 ± 0.06
Pitch of Component	P	25.4 ± 1	25.4 ± 1	25.4 ± 1	25.4 ± 1	25.4 ± 1	25.4 ± 1	25.4 ± 1	25.4 ± 1
Feed Hole Pitch	P0	12.7 ± 0.3	12.7 ± 0.3	12.7 ± 0.3	12.7 ± 0.3	12.7 ± 0.3	12.7 ± 0.3	12.7 ± 0.3	12.7 ± 0.3
Feed Hole Center to Lead	P1		3.85 ± 0.7		3.85 ± 0.7		3.85 ± 0.7		3.85 ± 0.7
Lead to Lead Distance (Center to Center)	F	7.5 ± 0.8	5.0 ± 0.8	7.5 ± 0.8	5.0 ± 0.8	7.5 ± 0.8	5.0 ± 0.8	7.5 ± 0.8	5.0 ± 0.8
Component Alignment	Δh	2.0 max	2.0 max	2.0 max	2.0 max	2.0 max	2.0 max	2.0 max	2.0 max
Basepaper Tape Width	W	18 +1/-0.5	18 +1/-0.5	18 +1/-0.5	18 +1/-0.5	18 +1/-0.5	18 +1/-0.5	18 +1/-0.5	18 +1/-0.5
Adhesive Tape Width	W0	10 min	10 min	10 min	10 min	10 min	10 min	10 min	10 min
Hole Position	W1	9 ± 0.5	9 ± 0.5	9 ± 0.5	9 ± 0.5	9 ± 0.5	9 ± 0.5	9 ± 0.5	9 ± 0.5
Adhesive Tape Border	W2	3 max	3 max	3 max	3 max	3 max	3 max	3 max	3 max
Component Height	H1	37 max	37 max	40 max	40 max	40 max	40 max	40 max	40 max
Lead-Wire Protrusion	Lx	1.0 max	1.0 max	1.0 max	1.0 max	1.0 max	1.0 max	1.0 max	1.0 max
Feed Hole Diameter	D0	4 ± 0.2	4 ± 0.2	4 ± 0.2	4 ± 0.2	4 ± 0.2	4 ± 0.2	4 ± 0.2	4 ± 0.2
Total Tape Thickness	t	»0.7 max	»0.7 max	»0.7 max	»0.7 max	»0.7 max	»0.7 max	»0.7 max	»0.7 max
Length of Clipped Lead	L	11 max	11 max	11 max	11 max	11 max	11 max	11 max	11 max
Component Height from Seating Plane	A	—	—	22.5 max	22.5 max	22.5 max	22.5 max	22.5 max	22.5 max
Hole Center to Component Center	P2		6.35 ± 0.7		6.35 ± 0.7		6.35 ± 0.7		6.35 ± 0.7

All dimensions are in Millimeters.

Note: Basepaper Thickness = 0.375mm ± 0.1mm (Ammo Box), 0.53mm ± 0.1mm (Reel)

Adhesive Tape Thickness = 0.16mm ± 0.03mm

Largest voltage which can be taped is 460VAC. For 320VAC and larger, only T15, T43, T38 or T4 is available

## 14mm Taping Specifications (continued)

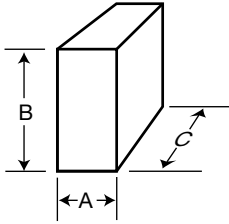

### Ammo Box

Ammo Box Taping Codes  
(T7, T36, T15, T43, T1U, T10, T8, T6)

A = 65 max  
B = 250 max  
C = 340 max

< 300VAC = 500 to 1,000 pieces  
≥ 300VAC = 300 pieces

**All dimensions are in Millimeters.**

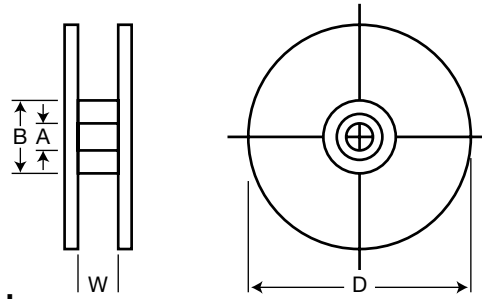

### Reel

Reel Taping Codes  
(T19, T18, T4, T38, T26, T1N, T16, T12)

W = Approximately 50  
D = 350ømax  
A = Approximately 30ø  
B = Approximately 95ø

< 300VAC = 500 to 1,000 pieces  
≥ 300VAC = 300 pieces

14mm Taping Specifications (continued)

**Straight Lead**  
**T7 ( Ammo Box) and T18 (Reel)**  
**(5mm Lead Spacing)**

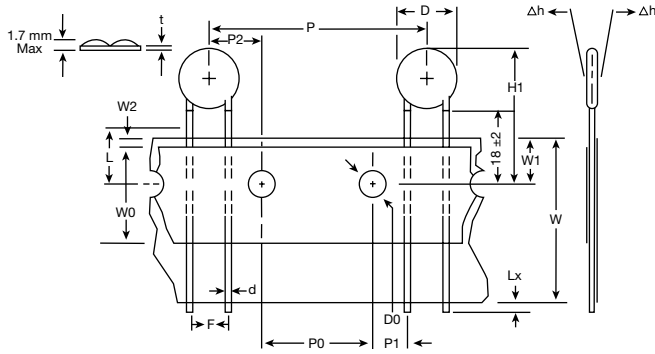

**Straight Lead**  
**T36 ( Ammo Box) and T19 (Reel)**  
**(7.5mm Lead Spacing)**

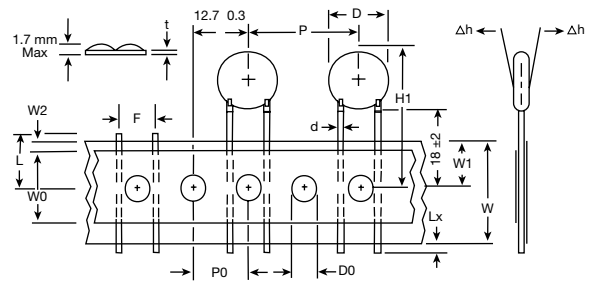

**In-Line Crimp**  
**T15 ( Ammo Box) and T38 (Reel)**  
**(5mm Lead Spacing)**

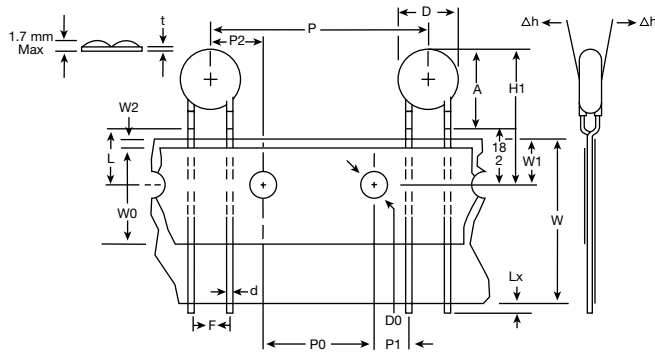

**In-Line Crimp**  
**T43 ( Ammo Box) and T4 (Reel)**  
**(7.5mm Lead Spacing)**

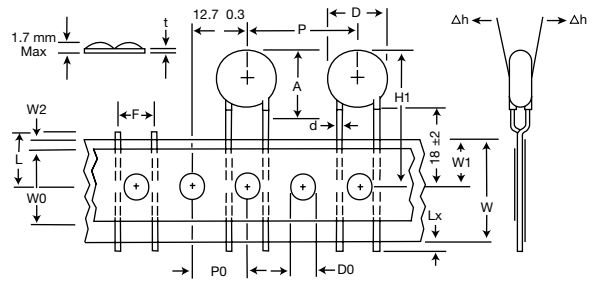

Based on EIA-468-B Specifications.

14mm Taping Specifications (continued)

**Outward Crimp**  
**T10 ( Ammo Box) and T26 (Reel)**  
**(5mm Lead Spacing)**

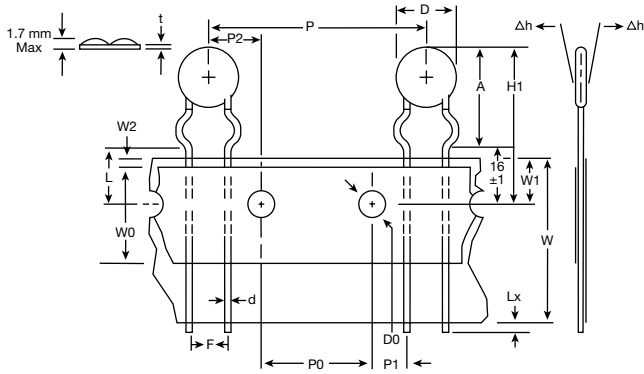

**Outward Crimp**  
**T1U ( Ammo Box) and T1N (Reel)**  
**(7.5mm Lead Spacing)**

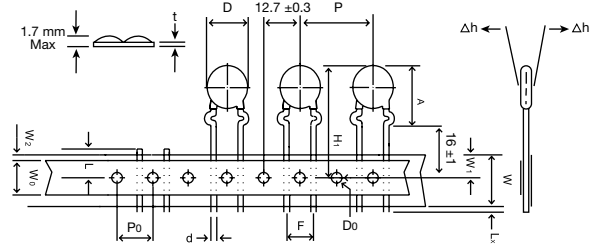

**Inward Crimp**  
**T6 ( Ammo Box) and T12 (Reel)**  
**(5mm Lead Spacing)**

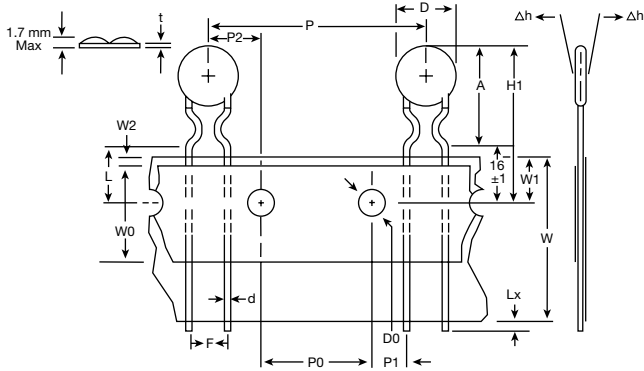

**Inward Crimp**  
**T8 ( Ammo Box) and T16 (Reel)**  
**(7.5mm Lead Spacing)**

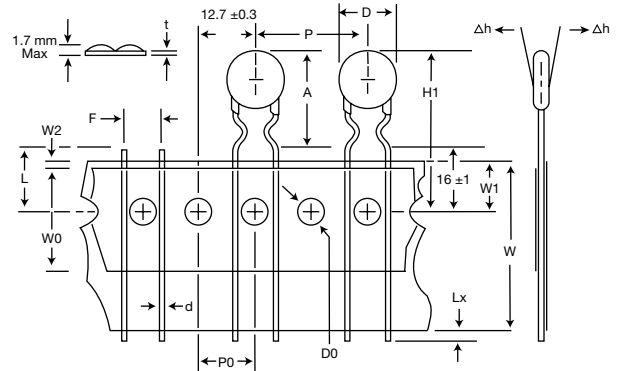



## 20mm Taping Specifications

Item	Symbol	Straight Leads		Outward Crimp		Inline Crimp		Inward Crimp	
		T44, T1H	T5, T30	T1X, T45	T50, T2X	T2, T25	T60, T3X	T40, T4X	T35, T2D
Body Diameter	D	24 max	24 max	24 max	24 max	24 max	24 max	24 max	24 max
Lead Wire Diameter	d	0.8 ± 0.06	1.0 ± 0.1	0.8 ± 0.06	1.0 ± 0.1	0.8 ± 0.06	1.0 ± 0.1	0.8 ± 0.06	1.0 ± 0.1
Pitch of Component	P	25.4 ± 1	25.4 ± 1	25.4 ± 1	25.4 ± 1	25.4 ± 1	25.4 ± 1	25.4 ± 1	25.4 ± 1
Feed Hole Pitch	P0	12.7 ± 0.3	12.7 ± 0.3	12.7 ± 0.3	12.7 ± 0.3	12.7 ± 0.3	12.7 ± 0.3	12.7 ± 0.3	12.7 ± 0.3
Lead to Lead Distance (Center to Center)	F	7.5 ± 0.8	10 ± 1	7.5 ± 0.8	10 ± 1	7.5 ± 0.8	10 ± 1	7.5 ± 0.8	10 ± 1
Component Alignment	Δh	2.0 max	2.0 max	2.0 max	2.0 max	2.0 max	2.0 max	2.0 max	2.0 max
Basepaper Tape Width	W	18+1/-0.5	18+1/-0.5	18+1/-0.5	18+1/-0.5	18+1/-0.5	18+1/-0.5	18+1/-0.5	18+1/-0.5
Adhesive Tape Width	W0	10 min	10 min	10 min	10 min	10 min	10 min	10 min	10 min
Hole Position	W1	9 ± 0.5	9 ± 0.5	9 ± 0.5	9 ± 0.5	9 ± 0.5	9 ± 0.5	9 ± 0.5	9 ± 0.5
Adhesive Tape Border	W2	3 max	3 max	3 max	3 max	3 max	3 max	3 max	3 max
Component Height	H1	48 max	48 max	48 max	48 max	48 max	48 max	48 max	48 max
Lead-Wire Clinch Height	H0	18 ± 2	18 ± 2	16 ± 1	16 ± 1	16 ± 1	16 ± 1	16 ± 1	16 ± 1
Lead-Wire Protrusion	Lx	1.0 max	1.0 max	1.0 max	1.0 max	1.0 max	1.0 max	1.0 max	1.0 max
Feed Hole Diameter	D0	4 ± 0.2	4 ± 0.2	4 ± 0.2	4 ± 0.2	4 ± 0.2	4 ± 0.2	4 ± 0.2	4 ± 0.2
Total Tape Thickness	t	»0.7 max	»0.7 max	»0.7 max	»0.7 max	»0.7 max	»0.7 max	»0.7 max	»0.7 max
Length of Clipped Lead	L	11 max	11 max	11 max	11 max	11 max	11 max	11 max	11 max
Component Height from Seating Plane	A	—	—	29 max	29 max	31 max	31 max	29 max	29 max

All dimensions are in Millimeters.

Note: Basepaper Thickness = 0.375mm ± 0.1mm (Ammo Box), 0.53mm ± 0.1mm (Reel).

Adhesive Tape Thickness = 0.16mm ± 0.03mm.

Largest voltage which can be taped is 460VAC.

For 320VAC and larger, only T2, T25, T60 or T3X is available

**DISCLAIMER:** The names of the products and the specifications in this catalog are subject to change without notice for the sake of improvement. World Products, LLC also reserves the right to discontinue any of these products. The products in this catalog are intended for use in ordinary electronic products. If any of these products are to be used in special applications requiring extremely high reliability, where product defects might pose a safety risk, please consult World Products, LLC. Though World Products, LLC has taken all possible precautions to ensure the quality and reliability of its products, improper use of products may result in bodily injury, fire, or similar accident. If you have any questions regarding the use of the products in question, please consult World Products, LLC. Please be advised that World Products, LLC accepts no responsibility for any infraction by users of World Products, LLC products on third party patents or industrial copyrights.

## 20mm Taping Specifications (continued)

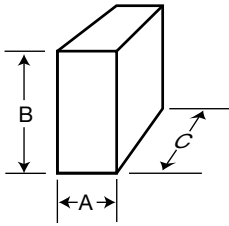

### Ammo Box

Ammo Box Taping Codes  
(T44, T5, T2, T60, T45, T50, T40, T35)

A = 65 max, B = 250 max  
C = 340 max

< 300VAC = 500 pieces, ≥ 300VAC = 300 pieces

All dimensions are in Millimeters.

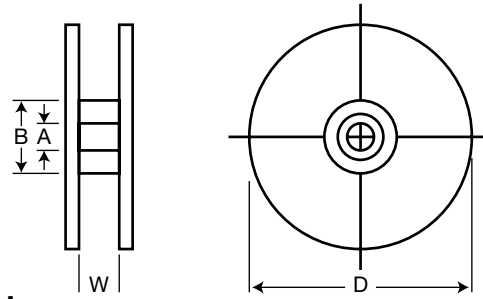

### Reel

Reel Taping Codes  
(T1H, T30, T25, T3X, T1X, T2X, T4X, T2D)

A = Approx. 30 $\phi$ , B = Approx. 95 $\phi$   
W = Approx. 50, D = 350 $\phi$ max

< 300VAC = 500 pieces, ≥ 300VAC = 300 pieces

### Straight Lead

T44 (Ammo Box) and T1H (Reel) (7.5mm Lead Spacing)  
T5 (Ammo Box) and T30 (Reel) (10mm Lead Spacing)

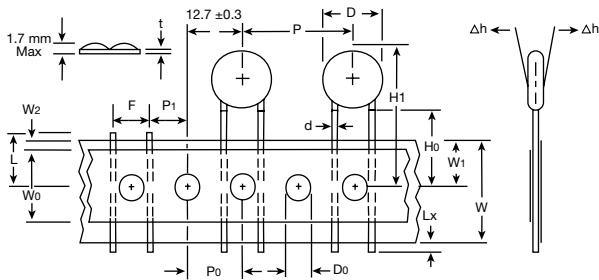

### In-Line Crimp

T2 (Ammo Box) and T25 (Reel) (7.5mm Lead Spacing)  
T60 (Ammo Box) and T3X (Reel) (10mm Lead Spacing)

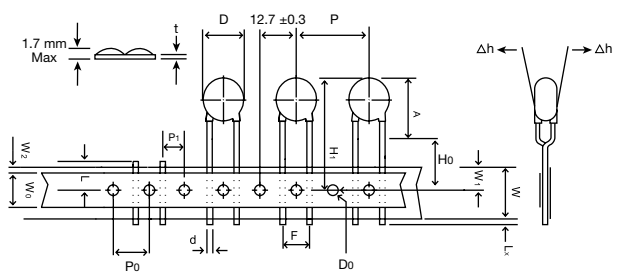

### Outward Crimp

T45 (Ammo Box) and T1X (Reel) (7.5mm Lead Spacing)  
T50 (Ammo Box) and T2X (Reel) (10mm Lead Spacing)

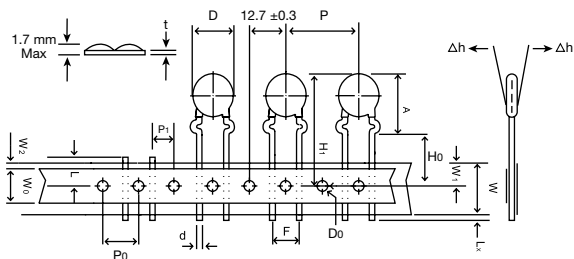

### Inward Crimp

T40 (Ammo Box) and T4X (Reel) (7.5mm Lead Spacing)  
T35 (Ammo Box) and T2D (Reel) (10mm Lead Spacing)

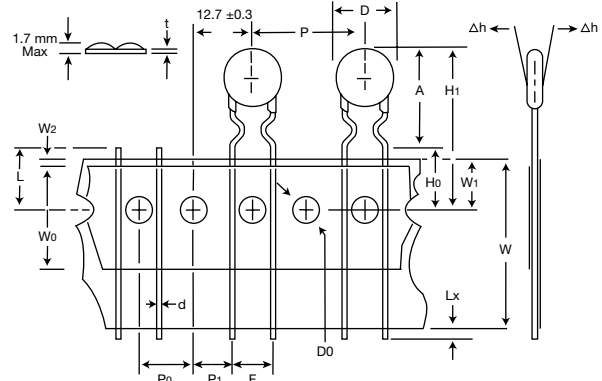

Based on EIA-468-B Specifications.

**THIS PAGE WAS INTENTIONALLY LEFT BLANK.**